

Secret

BARAUSSE

Secret

BARAUSSE



Index

04	MADE IN BARAUSSE	42	PORTE SCORREVOLI sliding doors
06	HIGH STANDARDS	54	PORTE BILICO pivot doors
10	SECRET	60	SOLUZIONI INTEGRATE A PARETE integrated wall solutions
14	SECRET YOU	68	PORTE TECNOLOGICHE technological doors
20	TIPOLOGIE APERTURA opening types	76	FINITURE finishings
26	PORTE BATTENTI hinged doors	82	AREA TECNICA technical area

Made in Barausse

Dal 1967 Barausse è specializzata nella produzione di **porte per interni**, 100% progettate e realizzate in **Italia**. Barausse sviluppa e propone soluzioni d'arredo funzionali alla separazione degli spazi, di **alto prestigio** e **valore estetico**, per creare ambienti dove vivere sia un'esperienza emozionante e confortevole. Forte di numerose **certificazioni** per porte resistenti al fuoco, della progettazione di prodotti **custom**, e la trentennale esperienza nel settore **contract**, Barausse opera nel mondo nella realizzazione di Hotel di lusso, strutture pubbliche, costruzioni residenziali e ville private.



Since 1967, Barausse has specialized in the production of interior doors which are 100% designed and manufactured in Italy. Barausse develops and offers furnishing solutions for the purpose of creating a separate space which is both functional and prestigious with a high esthetical value. The result is both a beautiful and comfortable place to live. Thanks to multiple certifications of our fire rated doors, the ability to design bespoke products and our over thirty years of experience in the contract field, Barausse is able to provide worldwide a high quality product for luxury hotels, for public buildings, high end residential and private homes.

Depuis 1967 Barausse est spécialisée dans la production de portes d'intérieur, 100% dessinées et réalisées en Italie. Barausse développe et propose des solutions fonctionnelles à la séparation des pièces, de grand prestige et valeur esthétique, pour créer des environnements où vivre une expérience excitante et confortable. Fort de nombreuses certifications pour portes résistantes au feu, de la conception de produits customisés et de l'expérience trentenaire dans le secteur contract, Barausse opère au niveau mondial dans la réalisation d'hôtels de luxe, structures publiques, constructions résidentielles et villas privées.

Desde 1967 Barausse es especialista en la producción de puertas para el interior, 100% diseñadas y hechas en Italia. Barausse desarrolla y propone soluciones funcionales para la separación de los espacios, de alto prestigio y valor estético, para crear lugares donde vivir sea una experiencia emocionante y confortable. De acuerdo con numerosas certificaciones de puertas resistentes al fuego, con la proyectación de productos a la medida, y con sus treinta años de experiencia en el sector contract, Barausse trabaja en todo el mundo desarrollando hoteles de lujo, estructuras públicas, construcciones residenciales y villas privadas.

С 1967 года Barausse специализируется в области производства дверей 100% спроектированных и реализованных в Италии. Barausse создает и предлагает функциональные интерьерные решения для разделения пространства, престижные и высоко эстетичные. Barausse обладает большое количество сертификатов на противопожарные двери, производит двери по индивидуальным проектам и имеет тридцатилетний опыт работы в сегменте больших проектов. Именно поэтому Barausse работает успешно над созданием интерьеров в гостиницах класса люкс, общественных зданиях, жилых комплексах и частных виллах.

High Standards

Macchinari altamente automatizzati consentono precisione nella realizzazione dei prodotti e puntuale monitoraggio del processo. All'interno di ogni porta viene inserita un RFID per il tracciamento e la rilevazione automatica dei dati di produzione.



Highly automated machines allow us to obtain high precision during production and careful monitoring of all processes. An RFID tag is inserted into each door to ensure traceability and permit production data to be read automatically.

Des machines hautement automatisées sont gage de précision dans la réalisation des produits et de monitoring précis du processus. Un RFID est ajouté à chaque porte pour tracer et relever automatiquement les données de production.

Riempitivo personalizzabile a seconda delle necessità: alveolare, truciolare forato, pannelli fonoisolanti o termoisolanti.

Custom filling based on the requirements: honeycomb, perforated chipboard, thermoinsulating panel or soundproof panel.

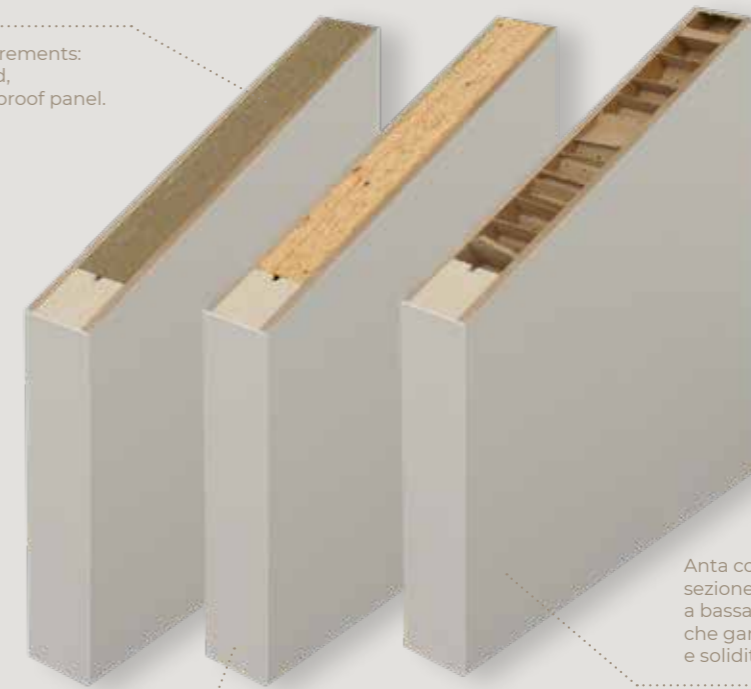

Anta con struttura di abete di ampia sezione e rivestimento in HDF da 6 mm a bassa emissione di formaldeide che garantisce stabilità, resistenza all'urto e solidità.

Leaf with a wide-section of fir perimetric structure and a 6 mm HDF covering which ensure stability, impact resistance and solidity.

I bordi dell'anta sono abbinati alle "facce" per un elegante effetto di continuità. In particolare, la bordatura inferiore protegge l'anta dall'assorbimento di umidità da pavimenti umidi.

Leaf edges are coordinated with the leaf surface in order to give an elegant effect of continuity. In particular, the lower edge protects leaf from absorption of floor humidity.

Nuestra maquinaria altamente automatizada permite la precisión en la fabricación de nuestros productos y una monitorización precisa del proceso. En el interior de cada puerta se introduce una etiqueta RFID para realizar un seguimiento y registro automático de los datos de fabricación.

Высокоавтоматизированное оборудование обеспечивает точность при изготовлении изделий и тщательный мониторинг процесса. В каждую дверь устанавливается РЧ-идентификатор для отслеживания и автоматического считывания производственных данных.

Green

Tutte le linee di prodotto sono realizzate rispettando parametri di qualità e certificazioni specifiche per il rispetto dell'ambiente e della salute. Le nostre porte sono realizzate con pannelli a bassa emissione di formaldeide, conformi alla normativa CARB2/TSCA cat.6. Legni e decorativi sono privi di sostanze tossiche, le laccature sono finite con vernici all'acqua, e gli incollaggi avvengono solo con colle viniliche senza emissione di formaldeide.



ISO 14001 Sistema gestione ambientale
Environmental management

ISO 9001 Sistema qualità
Quality management

All our product lines are made in compliance with quality parameters and specific environmental protection and health safety certifications. All our doors are made of low formaldehyde emission panels, compliant with the CARB2 / TSCA cat.6 standard. Decorative elements are free of toxic substances, lacquers are finished with water-based paints, and gluing takes place only with vinyl glues without formaldehyde emission.

Toutes les lignes de produits sont réalisées en respectant des paramètres de qualité et des certifications spécifiques de respect de l'environnement et de la santé. Toutes nos portes sont fabriquées avec des panneaux à faible émission de formaldéhyde, conformes à la norme CARB2 / TSCA catégorie 6. Les éléments décoratifs sont exempts de substances toxiques, les laques sont finies avec des peintures à l'eau et le collage se fait uniquement avec des colles vinyliques sans émission de formaldéhyde.

Todas las líneas de productos se fabrican respetando los parámetros de calidad y las certificaciones específicas para el respeto del medio ambiente y la salud. Todas nuestras puertas están fabricadas con paneles de baja emisión de formaldehído, cumpliendo con la norma CARB2 / TSCA cat.6. Las decoraciones están libres de sustancias tóxicas, las lacas tienen un acabado con pintura al agua y el pegado se realiza únicamente con colas vinílicas sin emisión de formaldehído.

Все линейки продукции изготавливаются с соблюдением параметров качества и сертификаций по охране окружающей среды и здоровья. Все наши двери изготовлены из панелей с низким уровнем выделения формальдегида, соответствующих стандарту CARB2 / TSCA cat.6. Декоры не содержат токсичных веществ, лакированные поверхности обрабатываются водоземulsionными лаками, а для склеивания применяются только не выделяющие формальдегид виниловые клеи.

SECRET

SECRET è la linea di porte filomuro che garantisce modernità e personalizzazione in ogni ambiente. Il telaio invisibile e l'anta realizzabile in infinite tonalità laccate, essenze legnose e finiture materiche, sono pensati appositamente per adattarsi a qualsiasi spazio. Una porta dal minimo impatto estetico disponibile anche nella versione YOU tinteggiabile, abbinata al battiscopa filomuro, o nella versione resistente al fuoco e fonoisolante.



SECRET is the flush door collection that allows customization and guarantees modernity in every environment. Its innovative frame and the customizable leaf, available in unlimited finishes, shades and wood veneers, are specifically designed to adapt perfectly to all spaces. A door with minimal design available also in the YOU paintable version, combined with the flush wall skirting board, or in the fire-rated and sound-insulating version.

SECRET est la gamme de portes affleurantes qui garantit modernité et personnalisation dans tous les environnements. Le cadre invisible en aluminium et le vantail disponible dans différentes finitions lacquées, une gamme infinie des nuances et essences de bois, sont conçus spécifiquement pour s'adapter parfaitement à tous les espaces. Une porte à l'impact esthétique minimal éalisée également dans la version YOU à peindre, combinée à la plinthe ras du mur, ou en en version coupe-feu et insonorisante.

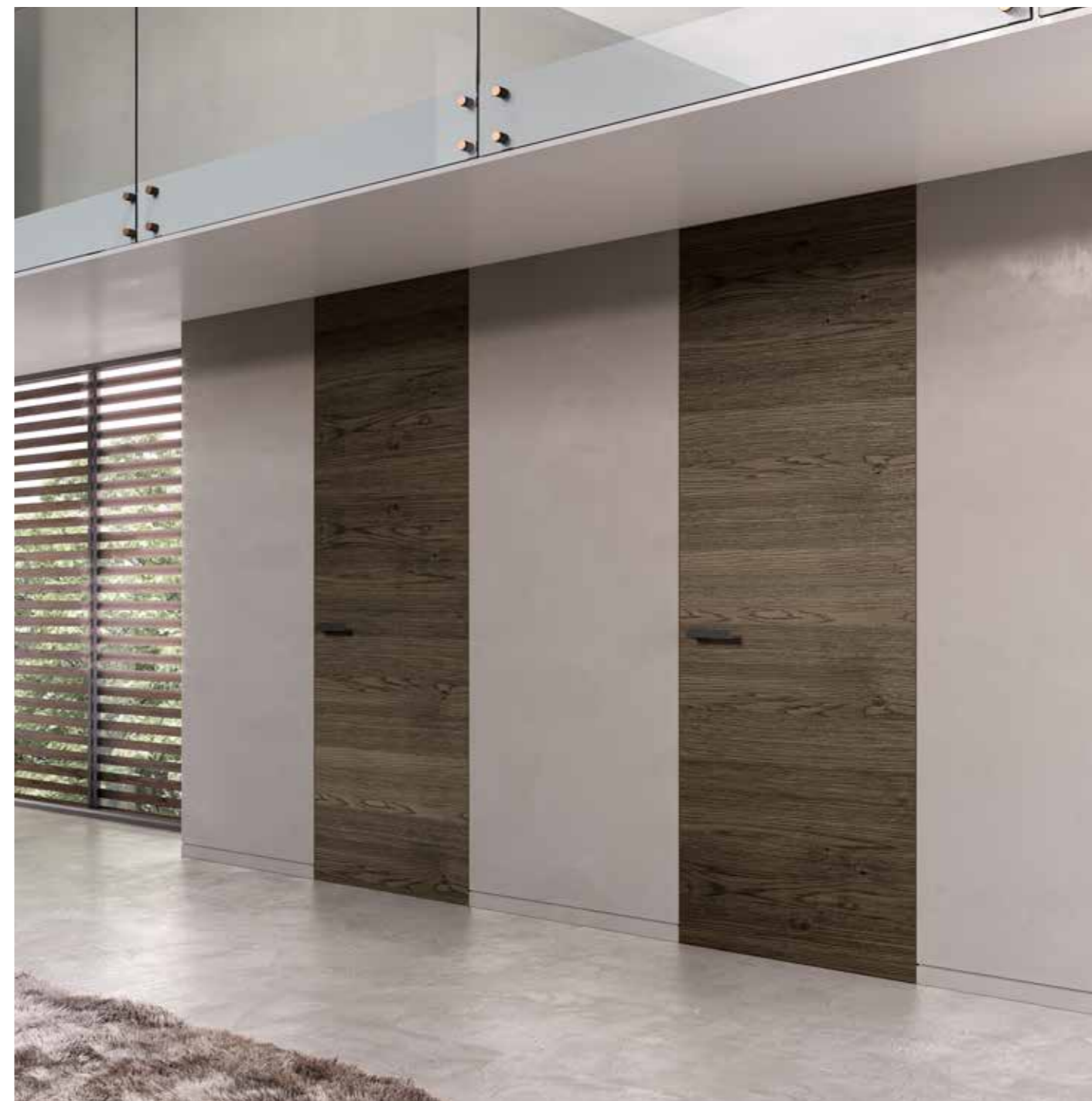

SECRET es una línea de puertas a ras de pared que garantiza modernidad y personalización en cada ambiente. El marco innovador y la hoja realizable en varios materiales y acabados son pensadas especialmente para adaptarse perfectamente a tus espacios. Una puerta que también está disponible en versión pintable YOU, en combinación con el zócalo a ras de pared o en versión resistente al fuego y acústica.

SECRET – это серия скрытых дверей, гарантирующих современный вид и индивидуальность в любой обстановке. Инновационные короб и полотно, представленное в различных материалах отделки, оттенках и видах древесины, специально разработаны, чтобы идеально соответствовать вашему пространству. Дверь с минимальным эстетическим воздействием также предлагается в отделке YOU под покраску, в сочетании со скрытым плинтусом, в раздвижной версии или в версии с повышенной огнестойкостью и звукоизоляцией



L'unicità del prodotto corrisponde a progetti dedicati, e prodotti indossabili. La porta diventa un'opportunità di personalizzare lo spazio, per renderlo coerente con l'ambiente circostante.



The uniqueness of the product corresponds to dedicated projects and wearable products. The door becomes an opportunity to customize the space, to make it consistent with the surrounding environment.

L'unicité du produit correspond à des projets dédiés et des produits portables. La porte devient l'occasion de personnaliser l'espace, de le rendre cohérent avec l'environnement qui l'entoure.

La singularidad del producto corresponde a proyectos dedicados y productos portátiles. La puerta se convierte en una oportunidad para personalizar el espacio, para hacerlo coherente con el entorno.

Уникальность товара соответствует выделенным проектам и выполненным на заказ. Дверь становится возможностью персонализировать пространство, чтобы оно соответствовало окружающей среде.

SECRET YOU

YOU rappresenta la soluzione per realizzare porte capaci di accogliere decorazioni o rilievi customizzabili. Abbiamo elevato la percezione di un oggetto funzionale che nasconde e svela simultaneamente, e il cui criterio progettuale si ispira al principio dell'organicità.

YOU is the right solution to make large doors that can hold decorations or customizable relief patterns. We have raised the perception of a functional object that hides and reveals simultaneously, and the design criteria was inspired by the principle of cohesiveness.





La soluzione YOU rappresenta la base per la massima personalizzazione dell'ambiente agevolando l'applicazione di carte da parati, finiture murali, vetri e specchi.

The YOU solution represents the basis for maximum personalization of the environment, facilitating the application of wallpapers, wall finishes, glass and mirrors.

La solution YOU représente la base d'une personnalisation maximale de l'environnement, facilitant l'application de papiers peints, de finitions murales, de verre et de miroirs.

La solución YOU representa la base para la máxima personalización del entorno, facilitando la aplicación de papel pintado, acabados de pared, cristales y espejos.

Решение YOU является основой для максимальной настройки среды, облегчая применение обоев, отделок стен, стекла и зеркал.

In linea con la filosofia Barausse, tutte le porte filomuro SECRET vengono fornite con le migliori cerniere invisibili disponibili sul mercato per la massima affidabilità.



In line with the Barausse philosophy, all SECRET flush doors are supplied with the best invisible hinges available on the market for maximum reliability.

Conformément à la philosophie Barausse, toutes les portes affleurantes SECRET sont fournies avec les meilleures charnières invisibles disponibles sur le marché pour une fiabilité maximale.

Siguiendo la filosofía de Barausse, todas las puertas invisibles SECRET se suministran con las mejores bisagras invisibles disponibles en el mercado para una máxima fiabilidad.

В соответствии с философией Barausse, все двери заподлицо SECRET поставляются с лучшими невидимыми петлями, доступными на рынке для максимальной надежности.



Tipologie apertura

QUERCIA IN - Bronze SID 60
TOTAL handle



Tipologie di apertura

door opening types

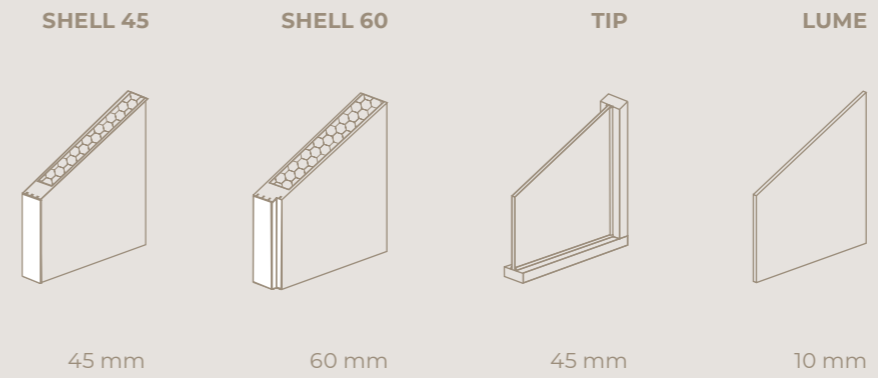
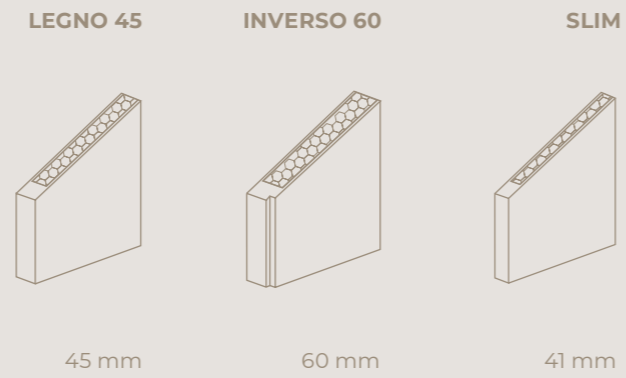

		LEGNO 45	INVERSO 60	SLIM
Battente Hinged	telaio rasomuro flush frame	●	●	----
Bilico Pivot	con battuta with SECRET frame	----	●	----
	senza battuta with no frame	●	----	----
Scorrevole a scomparsa Pocket	rasomuro flush pocket	●	----	●
Scorrevole a parete Barn	con binario invisibile FILA with invisible rail FILA	●	----	----
	con binario a vista PARI wall mounted system PARI	●	----	----
Scorrevole a soffitto Ceiling sliding	con binario incassato VOLTA concealed rail VOLTA	●	----	----
	con binario a vista VOLTA visible pelmet VOLTA	●	----	----

		SHELL 45	SHELL 60	TIP	LUME
		●	●	●	●
		●	●	●	----
		----	----	●	----
		●	----	●	●
		●	----	----	●
		●	----	●	----
		●	----	●	----

Apertura battente

hinged doors opening
ouverture des portes battantes
apertura de puertas batientes
виды распашных дверей



Anta singola

single leaf
vantaile seule
hoja simple
одностворчатое полотно

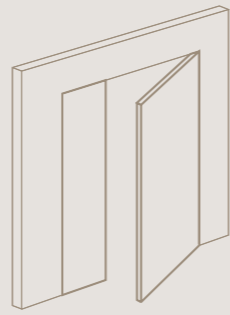

anta doppia

double leaf
porte double
hoja doble
двустворчатое полотно



filo soffitto

flush to ceiling
à ras du plafond
ras de techo
в потолок

Apertura bilico

pivot door
porte pivotante
puerta pivotante
pivot дверь

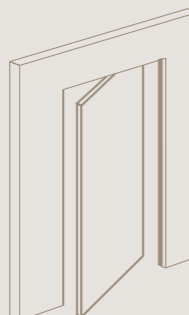

con telaio rasomuro SECRET

with SECRET frame
avec cadre SECRET
con marco SECRET
с рамкой SECRET

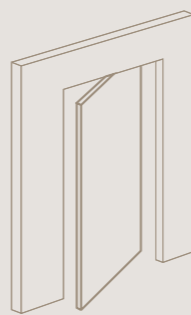

senza battuta

frameless
sans cadre
sin marco
без рамки

Apertura scorrevole

sliding doors solutions
solutions coulissantes
soluciones para puertas correderas
виды раздвижных дверей

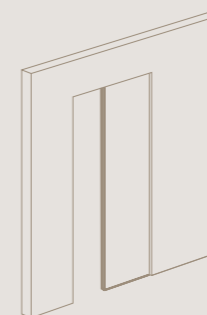

scorrevole a scomparsa

flush pocket door
porte coulissante rétractable
puerta corredera interior
раздвижные в пенал без обрамления
проема

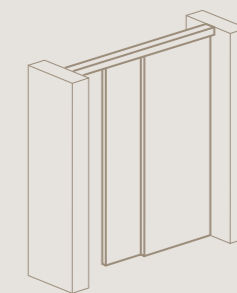

VOLTA con binario esterno, in nicchia

with visible pelmet, in niche
avec rail de guidage externe, en niche
con guía externa, en nicha
потолочная раздвижная дверь
с внешним рельсом в проеме

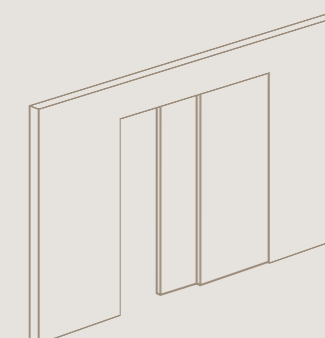

VOLTA con binario incassato

with concealed rail
avec rail de guidage encastré
con guía empotrada en el techo
с потолочным встраиваемым рельсом

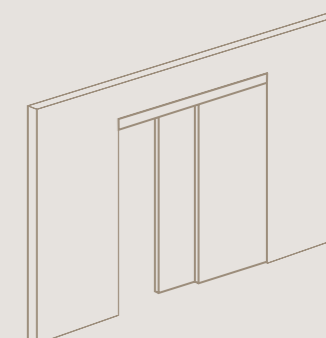

VOLTA con binario esterno

with visible pelmet
avec rail de guidage externe
con guía externa
потолочная раздвижная дверь
с внешним рельсом

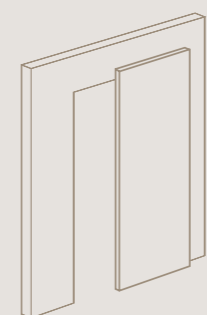

scorrevole esterna FILA

barn door with invisible track
porte coulissante le long d'un mur
puerta corredera externa
раздвижная вдоль стены

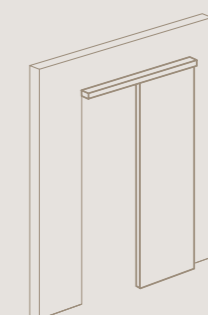

PARI con mascherina

with pelmet
avec élément masquant
con cubre guía
с декоративным наличником

Hinged doors

Porte battenti

SHELL VSL,
LOTUS Q handle



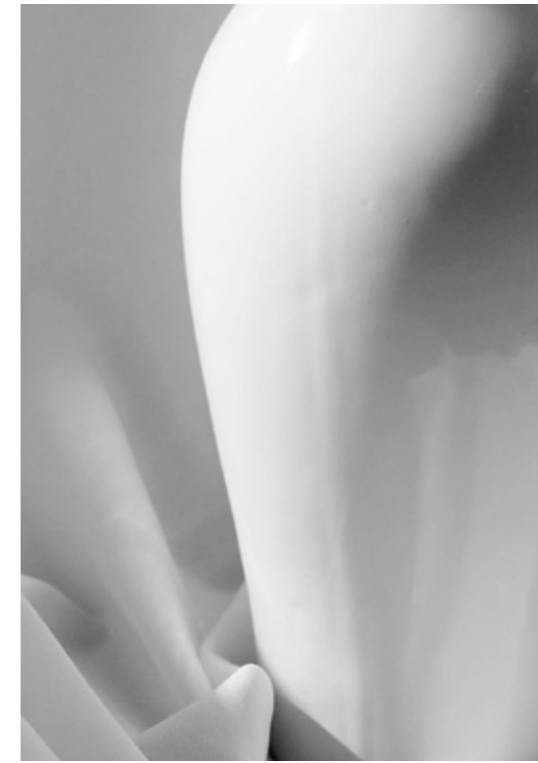

BIANCO ON,
TOTAL handle



TORTORA SHINY ON,
PUSH handle





COLOR ON & YOU,
PURA handle



L'innovativa laccatura METAL dona anche alla semplice anta piana una particolare texture materica dall'effetto inconfondibilmente unico e raffinato.

The innovative METAL lacquered finish gives these flat doors a unmistakable surface texture with a unique, refined effect.

BRONZE METAL ON,
TOTAL handle



NODATO ON,
ROBOCINQUE S handle



QUERCIA ON,
TIPA120 handle,
SECRET frame & barn door with invisible
rail - FILA



TRAVERTINO,
TOTAL handle



Sliding doors

Porte scorrevoli

RAME TIP 090,
integrated handle,
VOLTA sliding system





ORO TIP 60 & I30,
integrated handle,
VOLTA sliding system



TALPA SOFT PURA,
TIPA30 handle,
flush pocket door



NATUROC BIT,
Flush pocket door
& PARI sliding system

Venature spazzolate e verniciate con cura per esaltare al massimo ogni dettaglio della pregiata essenza: le porte in legno della collezione Nature Barausse sono concepite per arredare e dividere gli spazi con il pregio del legno e il fascino delle sue irregolarità, in equilibrio tra classico e contemporaneo.

Carefully brushed and varnished veins to highlight every detail of the prestigious veneer: the wood doors of Nature Barausse collection are conceived to furnish and divide spaces with quality wood and the charm of its irregularities, in balance between classic and contemporary.

Des veines brossées et soigneusement vernies pour maximiser chaque détail de l'essence précieuse: les portes en bois de la collection Barausse Nature sont conçues pour meubler et diviser les espaces avec la valeur du bois et le charme de ses irrégularités, dans un équilibre entre classique et contemporain.

Grano de madera cepillado y acabado con barniz especial para exaltar al máximo cada detalle de la chapa preciosa: las puertas de madera de la colección Nature Barausse son concebidas para decorar y dividir los espacios con el calor de madera y el encanto de sus irregularidades, en equilibrio entre el estilo clásico y el estilo contemporáneo.

Обработанные щеткой и тщательно покрытые лаком прожилки, чтобы максимально подчеркнуть каждую деталь драгоценной сущности: деревянные двери коллекции Barausse Nature созданы, чтобы отделить и разделить пространство ценностью дерева и очарованием его неровностей в балансе между классикой и современностью.



NATNUT ON,
barn door with invisible rail - FILA



NATNUT ON,
TIPA30 handle,
barn door with invisible rail - FILA

Pivot doors

Porte bilico

TR MARMO SHELL,
TIPA30 handle,
pivot system





TABACCO IN,
pivot system



NATNUT ON,
pivot system

Soluzioni integrate a parete

TABACCO IN,
TIPA120 handle,
INNER X1 frame





TABACCO IN,
TOTAL handle



COLOR COLONIALE,
TIPA30 handle,
pivot system



YOU - MARGRAF marble,
pivot system

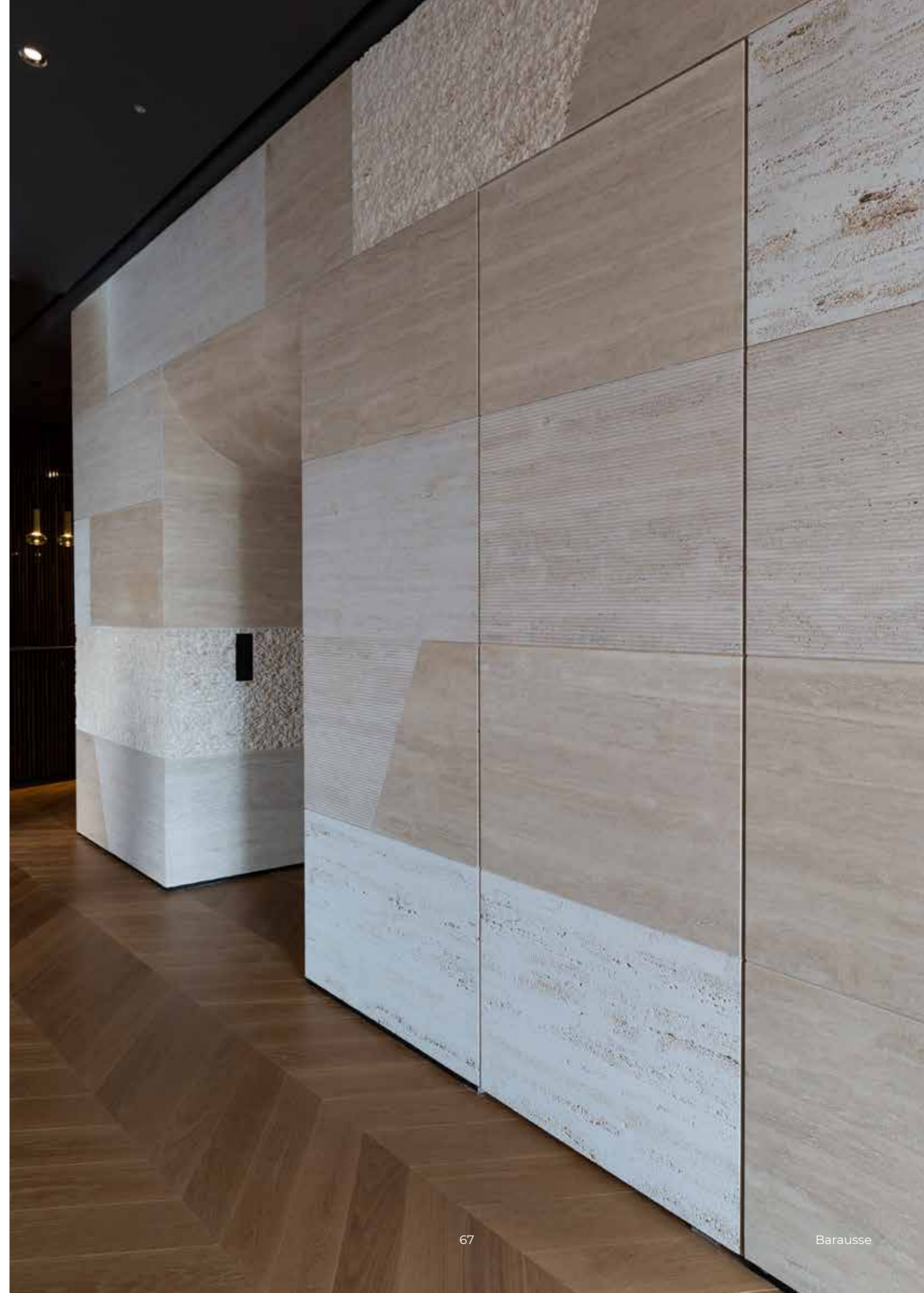

Porte tecnologiche

custom milled door BRONZE METAL ON,
LINK L200 handle





custom milled door BRONZE METAL ON,
LINK L200 handle,
fire rated single door



custom milled door BRONZE METAL ON,
LINK L200 handle,
fire rated double door

Porte resistenti al fuoco

fire rated doors

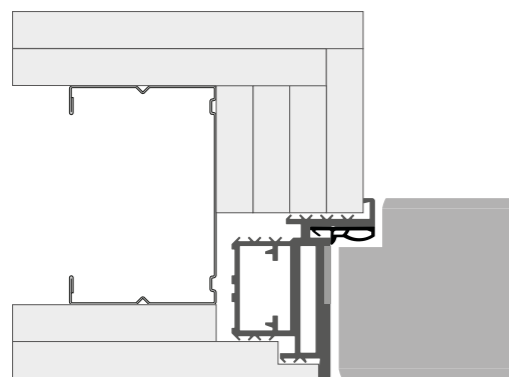

HTBS-4 (aluminum frame)

filomuro a tirare
flush with the wall on the pulling side
"заподлицо" со стеной, с открыванием на себя
au ras du mur à tirer
a ras de la pared de tirar

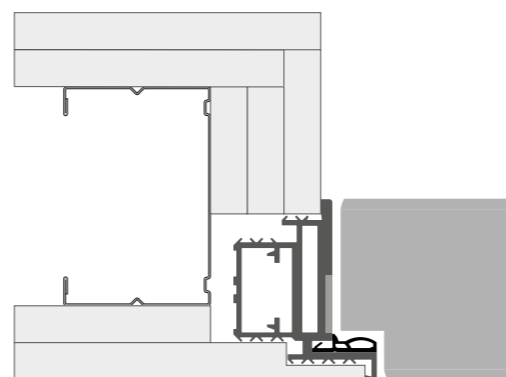
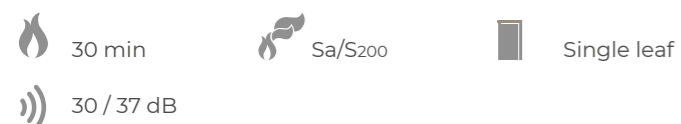

HTBS-4 (aluminum frame)

filomuro a spingere
flush with the wall on the pushing side
"заподлицо" со стеной, с открыванием от себя
au ras du mur à pousser
a ras de la pared de empujar

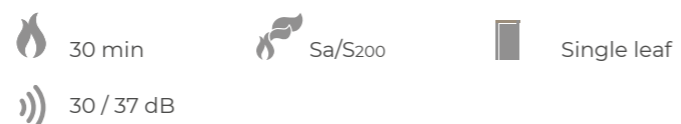

Porte fonoisolanti telaio TECNOSECRET

sound proof doors TECNOSECRET frame

UNI EN

ISO 717-1:2013
ISO 140/3

leaf thickness	dimension	hinges)))
45 mm	up to 900 x 2400 mm	3 ST311	30 dB
	up to 900 x 2400 mm	3 ST311	37 dB
60 mm	up to 900 x 2400 mm	3 ST311	30 dB
	up to 900 x 2400 mm	3 ST311	37 dB

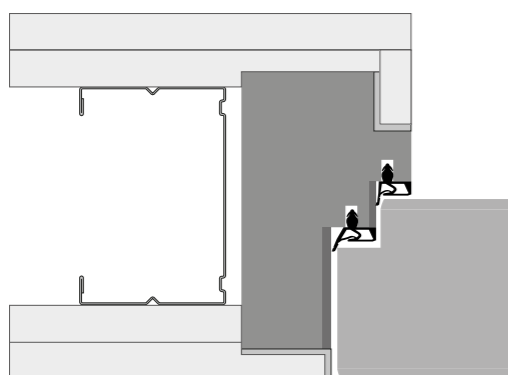

HTBS-8 (wooden frame)

filomuro a tirare
flush with the wall on the pulling side
"заподлицо" со стеной, с открыванием на себя
au ras du mur à tirer
a ras de la pared de tirar

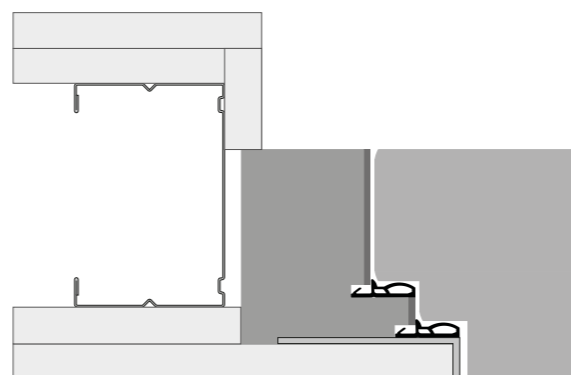

HTBS-8 (wooden frame)

filomuro a spingere
flush with the wall on the pushing side
"заподлицо" со стеной, с открыванием от себя
au ras du mur à pousser
a ras de la pared de empujar

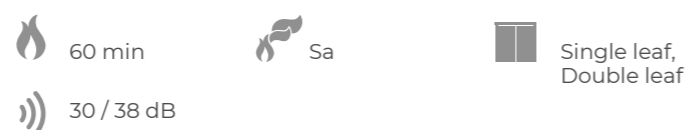

Soglia Mobile

È un profilo tecnico applicato nella parte inferiore dell'anta con funzioni di: isolante termico, isolante acustico, tenuta ai fumi freddi.

Mobile threshold

This is a technical profile applied to the lower part of the leaf with the following purposes: thermal insulation, acoustic insulation, cold smoke proof.

Seuil mobile

Profil technique appliqué sur la partie inférieure du vantail ayant des fonctions: isolant thermique, isolant acoustique, tenue fumées froides.

Umbral móvil

Es un perfil técnico aplicado en la parte inferior de la hoja con funciones de: aislante térmico, aislante acústico, resistencia a los humos fríos.

Выдвижно порог

технический профиль, установленный в нижней торцевой части дверного полотна и служащий в качестве: термоизоляции, акустической изоляции, защиты от дыма.



NATNUT ON & TORTORA,
custom handle,
TECNOSECRET frame

Finiture

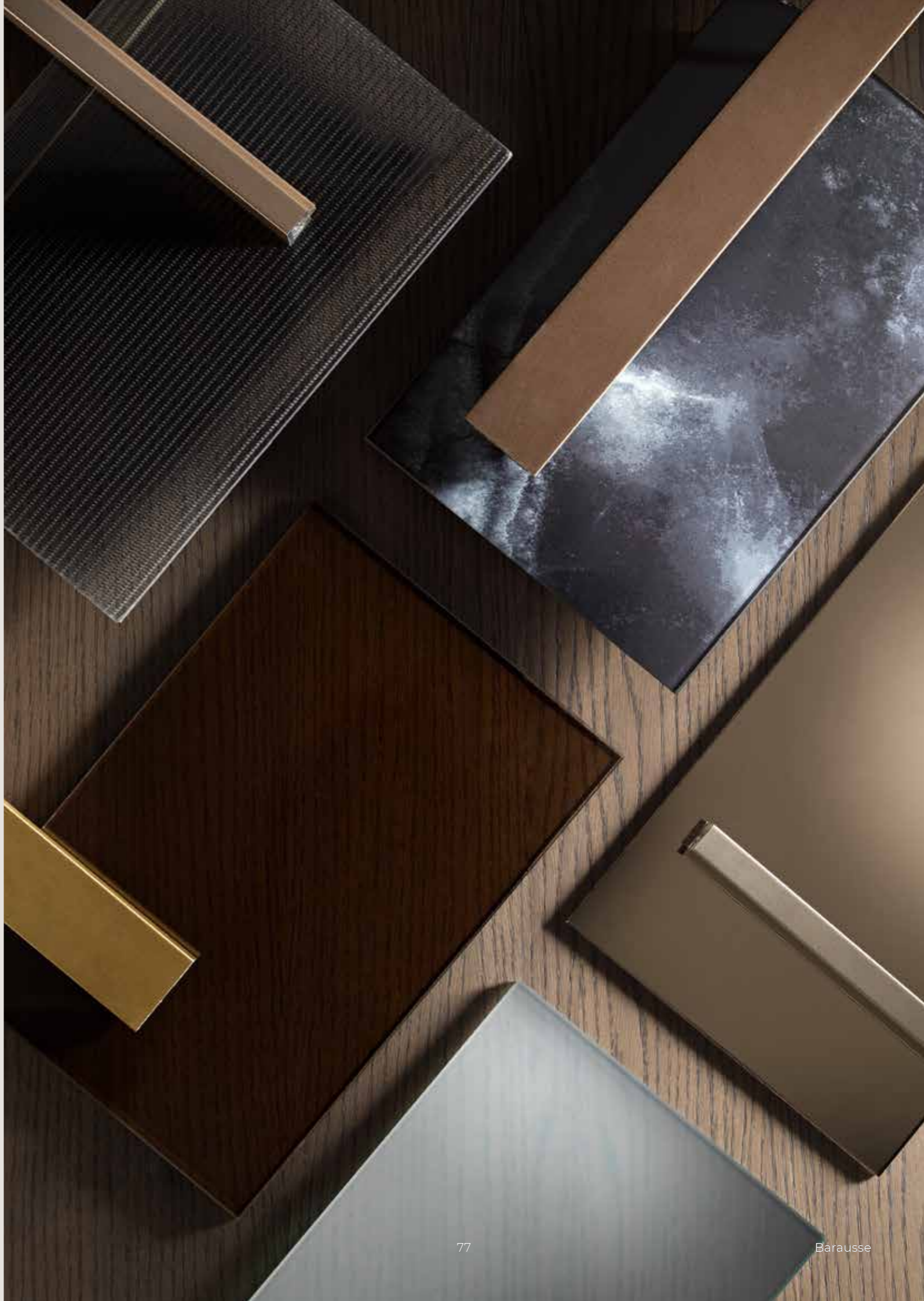

Colore

color

LACCATO

lacquered - laqué - lacado
крашенная

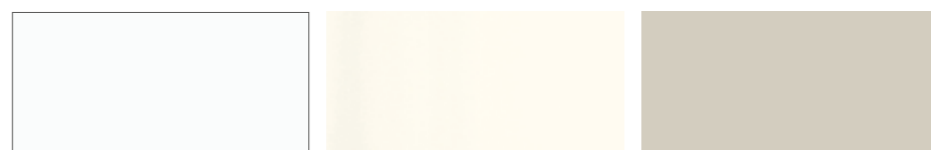

BLANC MAGNOLIA TORTORA



NUVOLA COLOR

LACCATO SOFT

soft lacquered - laqué soft - lacado
soft - soft крашенная



TORTORA SOFT NUVOLA SOFT GRIGIO SOFT



TALPA SOFT COLOR SOFT

LUCIDO

shiny - brillant - brillante
глянцевый

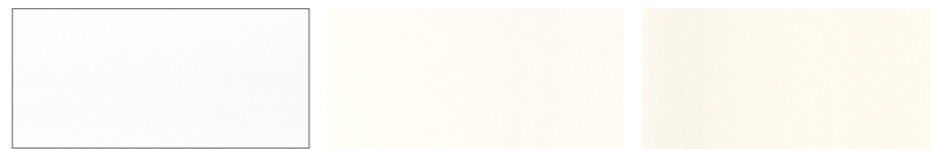

BIANCO LATTE CREMA



TORTORA SHINY GRIGIO SHINY NERO SHINY

LACCATO METAL

METAL lacquered - laqué METAL
lacado METAL - METAL крашенная



ALUM TITANIO CHAMPAGNE



ORO BRONZE BRONZO ANTICO



RAME CARBON

Legno

wood

NATURE ECO

tranciato di legno - pure wood veneer
placage de bois - chapa de madera -
древесный шпон



NATUROC
rovere naturale spazzolato - natural
brushed oak - chêne brossé naturel
roble natural cepillado - дуб
натуральный брашированный

NODATO
rovere naturale nodato spazzolato
natural brushed oak with knots -
chêne brossé naturel, noeuds en vue
roble natural cepillado con nudos -
натуральный брашированный дуб
с узловатостями

NATNUT
noce americano - american walnut
noyer américain - nogal americano
орех американский



SIGARO
rovere naturale spazzolato - natural
brushed oak - chêne brossé naturel
roble natural cepillado - дуб
натуральный брашированный

CENERE
rovere grigio nodato spazzolato -
grey brushed oak with knots - chêne
brossé cendre, noeuds en vue - roble
gris cepillado con nudos - серый дуб
узловатый брашированный

TABACCO
rovere spessart termotrattato
spazzolato - spessart heat treated and
brushed oak - chêne spessart thermo
traité et brossé - roble termotrattado
cepillado - термообработанный
брашированный дуб



COLOROC
rovere laccato - lacquered oak -
chêne laqué - roble lacado - дуб
лакированный

ICE
frassino laccato blanc spazzolato -
blanc lacquered brushed ash -
frêne laqué blanc brossé - fresno
lacado blanc cepillado - ясень
брашированный blanc крашенная

MASAI
rovere nero spazzolato - black brushed
oak - chêne noir brossé - roble negro
cepillado - дуб брашированный
черный

NATURE

tranciato di legno verniciato a poro
aperto - pure wood veneer
with open pores - placage de bois
verni à pores ouverts - chapa de
madera barnizada de poro abierto -
древесный шпон лакированный
с открытыми порами



SESAMO
tranciato precomposto -
reconstructed wood veneer - placage
de bois reconstitué - chapa de
madera precompuesta -
композитный деревянный шпон

OLMO
olmo - elm - orme - olmo - вяз

GRALLEY
rovere grigio - grey oak - chêne gris
roble gris - дуб серый

ESSENZE

piallaccio di legno precomposto -
reconstructed wood veneer - placage
de bois reconstitué - chapa de
madera precompuesta -
многослойный шпон

Materico

materico

BAKLITE EFFETTO CEMENTO

concrete effect - effet béton -
Эффект цемента - efekt cementu
efecto del hormigón



CEMENTO



CORDA



PIETRA



ARDESIA

PELLE

leather - cuir - piel - кожа



B



N

EFFETTO PIETRA

stone effect - effet pierre - efecto
piedra - под камень



TRAVERTINO



ROCK

EFFETTO LEGNO

wood effect - effet bois - efecto
madera - эффект дерева



GHIACCIO



BRINA



OTTER



PERLA



WALNUT



MOKA



QUERCIA

Vetro

glass

TRASPARENTE

transparent - transparent -
transparente - прозрачное

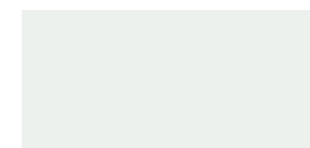

VT TR EXTRA



VST TR



VT TR FUMÉ

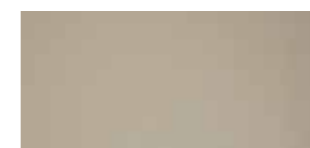

VT TR BRONZO



SS FUMÉ

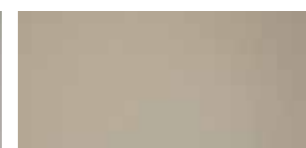

SS BRONZO

SATINATO

frosted - satiné - satinado - матовое

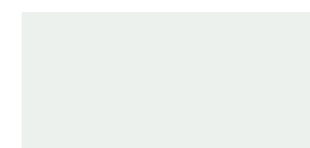

VSS SB EXTRA



VSS SB



VTS FUMÉ

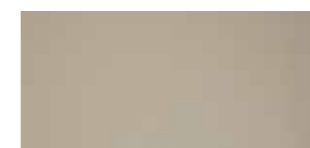

VTS BRONZO



LACCATO COLORE
LUCIDO

back lacquered - vitrage
laqué - vidrio lacado -
лакированное блестящее



VSL

SPECCHIO

mirror - miroir - espejo - зеркало



SSP VANITÀ



SSP FUMÉ



SSP BRONZO

DECORATO

decorative glass - vitrage décoré
vidrio decorado - стекла
прозрачные с декором



TR FUMÉ M1



TR M2



TR BRONZO M2



TR EXTRA L1

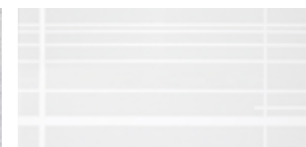

VSD LINEN



VSD LINEA



TR EXTRA PRINT



TR FUMÉ PRINT



TR BRONZO PRINT



TR EXTRA P1



TR PRINT MARMO

Technical area

Area tecnica



Telai filomuro

flush frames

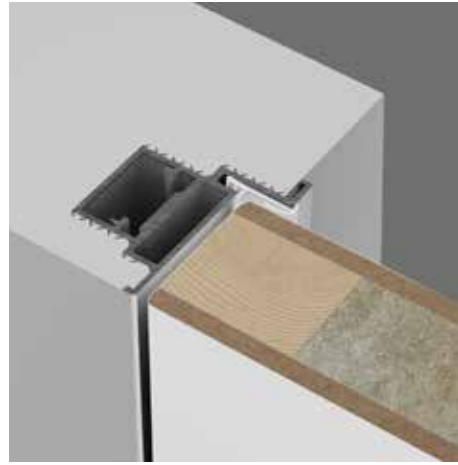

SECRET / flush on the pull side

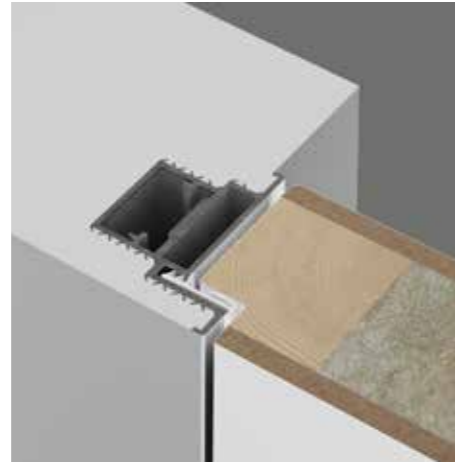

SECRET / flush on the push side



INNER X1 / flush on the pull side

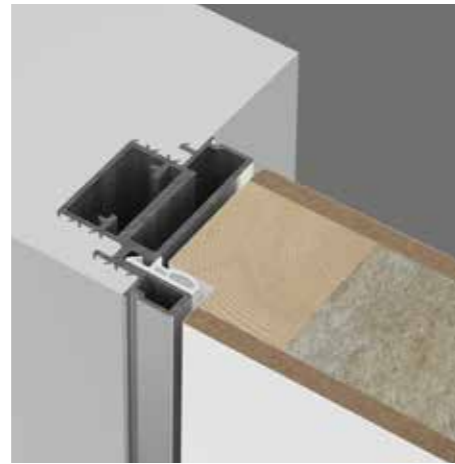

INNER X1 / flush on the push side



INNER2 / flush on the pull side

Soluzioni integrate a parete

integrated wall solutions

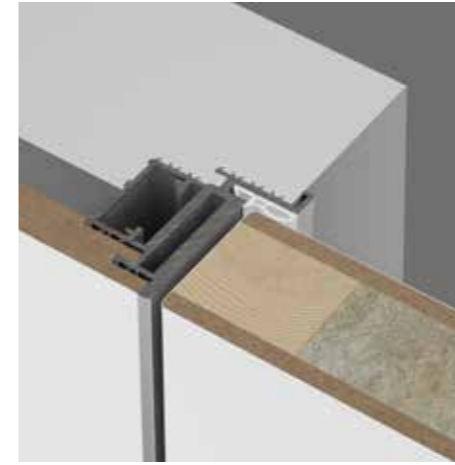

TECNOSECRET / flush on the pull side

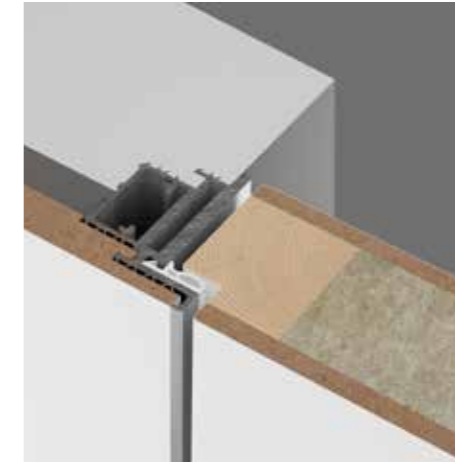

TECNOSECRET / flush on the push side



INNER X1 / flush on the pull side

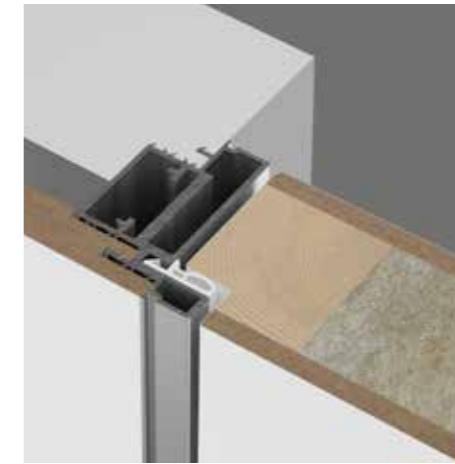

INNER X1 / flush on the push side

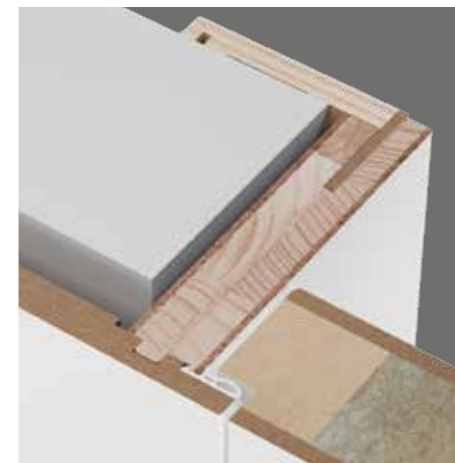

TN PLUS INVERSO / flush on the push side

	SECRET	TECNOSECRET
Un unico telaio sia per cartongesso che per muratura A single frame for both plasterboard and brickwork	•	•
Un unico telaio sia per la versione a spingere che a tirare A single frame for both the "push" and the "pull" versions	•	•
Realizzabile in tutte le altezze fino a 300 cm Available in all heights up to 300 cm	•	•
Fonoisolamento certificato fino a 37 dB Sound insulating certifications up to 37 dB	-----	•
Porta REI Fire resistant door	-----	•
Telaio preverniciato bianco pitturabile White pre-varnished paintable frame	•	•
Cerniere invisibili registrabili su 3 assi Invisible hinges adjustable on 3 axes	•	•
Integrazione con battiscopa filomuro Integration with flush-to-the-wall skirting board	•	•
Integrazione in boiserie Integrated into wall panelling	Affiancamento alla boiserie placed side by side with the wall panelling	Aggancio alla boiserie hooked on wall panelling

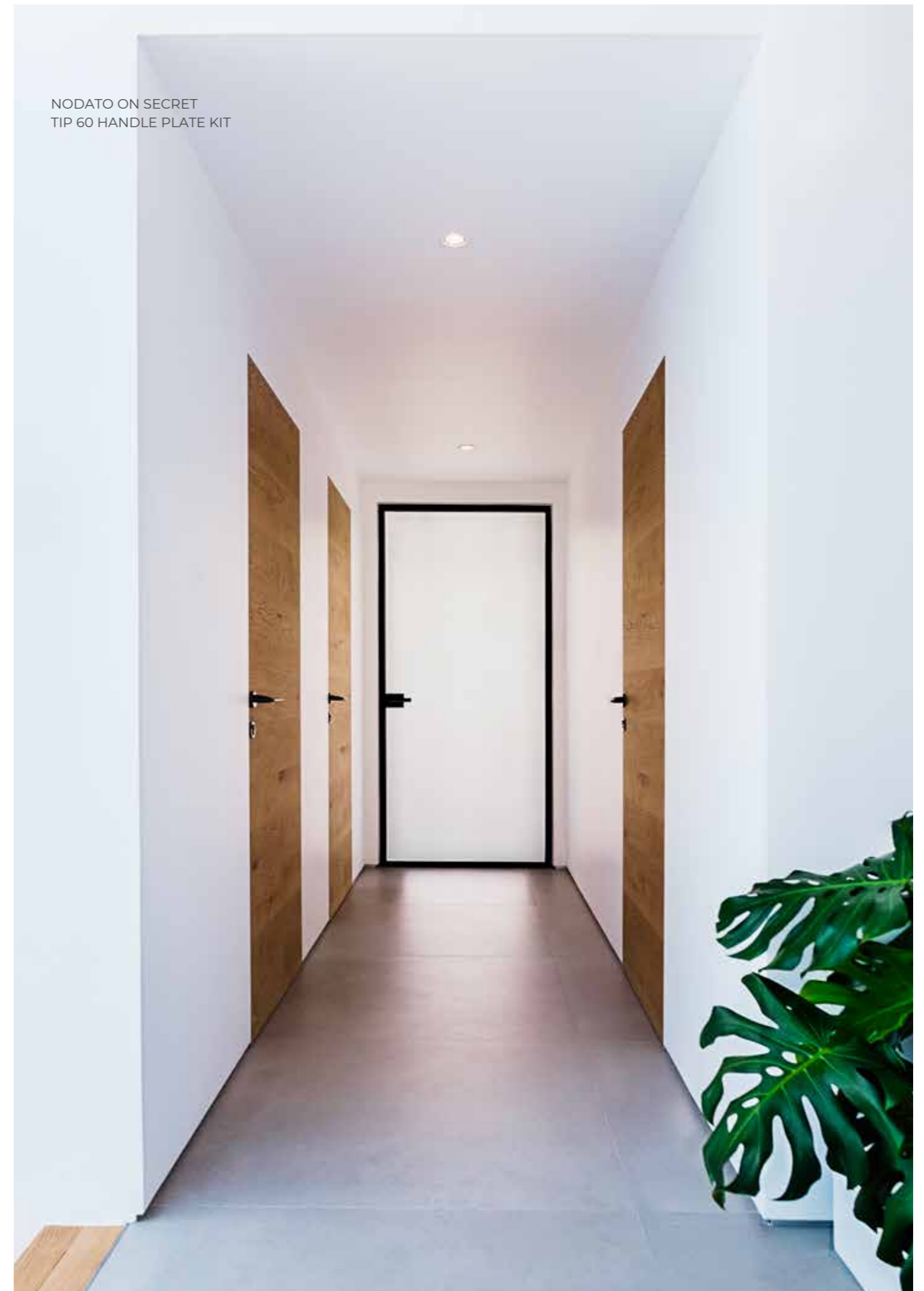

Telaio SECRET

SECRET frame

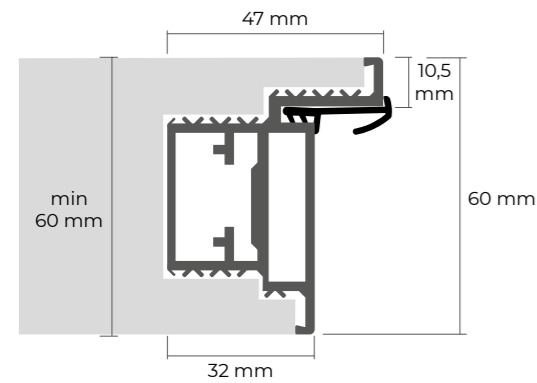

Telaio TECNOSECRET

TECNOSECRET frame

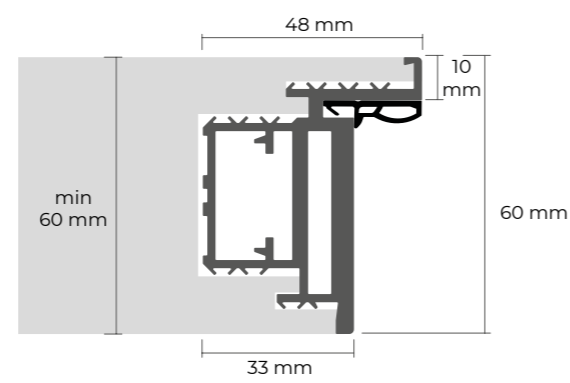

Telaio INNER X1

INNER X1 frame

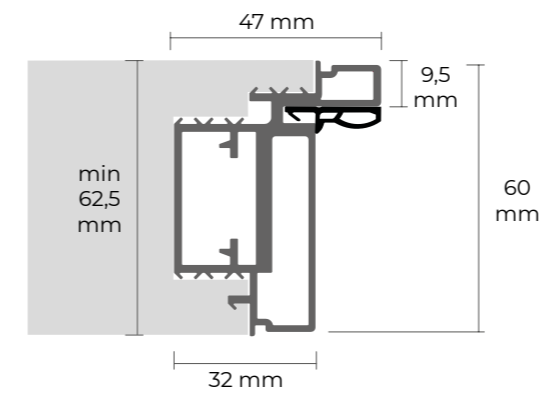

Telaio INNER2

INNER2 frame

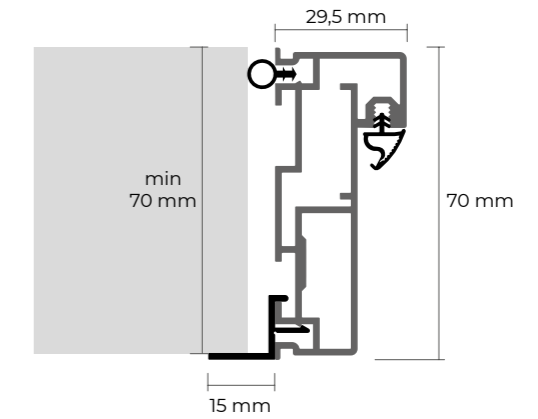

L = LM - 100 mm
LA = L + 14 mm

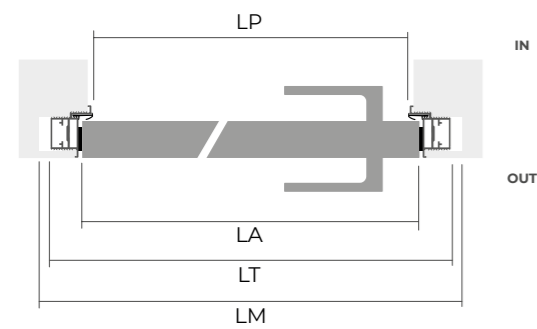

COMPLANARITÀ A TIRARE
flush on the pull side / 45 mm

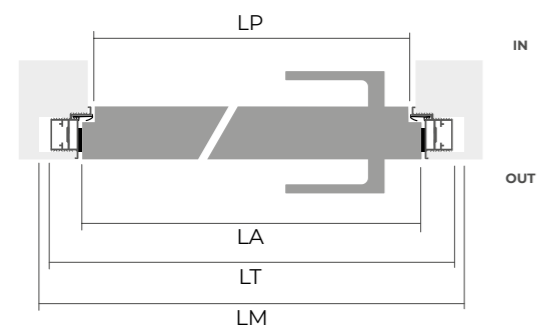

COMPLANARITÀ A TIRARE
flush on the pull side / 60 mm

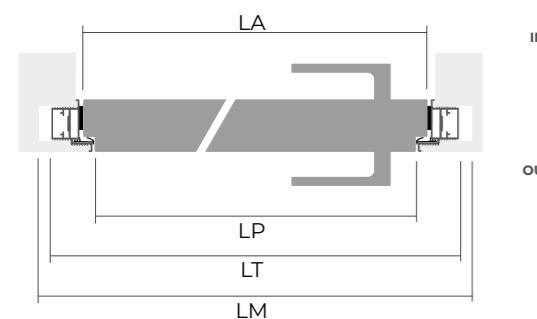

COMPLANARITÀ A SPINGERE
flush on the push side / 60mm

L = larghezza nominale
leaf nominal width
LA= larghezza reale anta
leaf real width
LV= larghezza vano
finished wall width
LM= larghezza foro muro
rough finished wall width
LP= luce passaggio telaio
frame passage width
LT = larghezza telaio
frame width
LC= ingombro coprifili
overall width

L = LM - 100 mm
LA = L + 14 mm

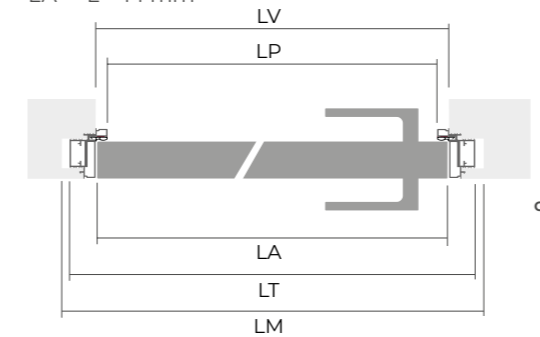

COMPLANARITÀ A TIRARE
flush on the pull side / 45 mm

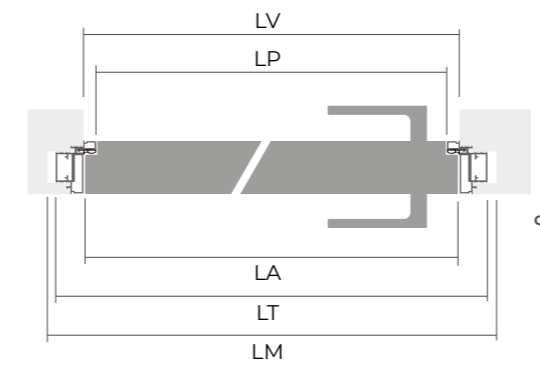

COMPLANARITÀ A TIRARE
flush on the pull side / 60 mm

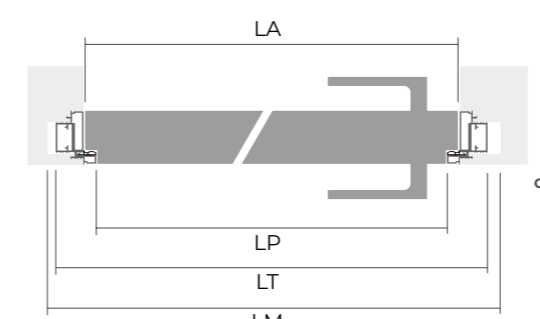

COMPLANARITÀ A SPINGERE
flush on the push side / 60 mm

L = LM - 70 mm
LA = L + 14 mm

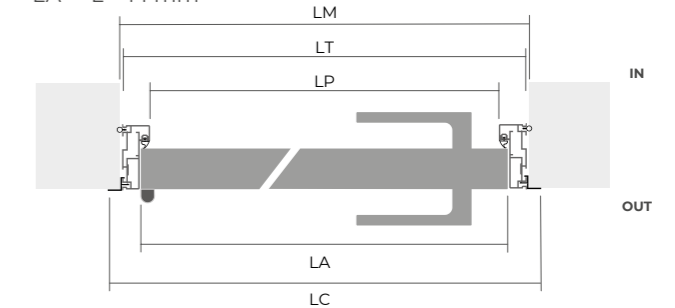

COMPLANARITÀ A TIRARE
flush on the pull side / 45 mm

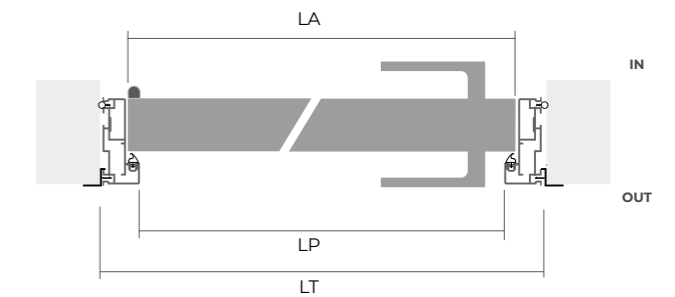

SPINGERE
push side / 45 mm

L = larghezza nominale
leaf nominal width
LA= larghezza reale anta
leaf real width
LV= larghezza vano
finished wall width
LM= larghezza foro muro
rough finished wall width
LP= luce passaggio telaio
frame passage width
LT = larghezza telaio
frame width
LC= ingombro coprifili
overall width

Bilico - senza battuta

Pivot door - with no frame

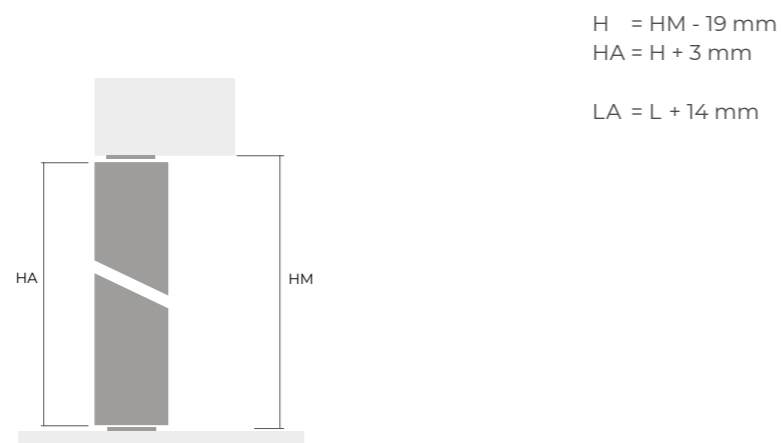

Bilico - con telaio rasomuro SECRET

Pivot door with SECRET flush frame

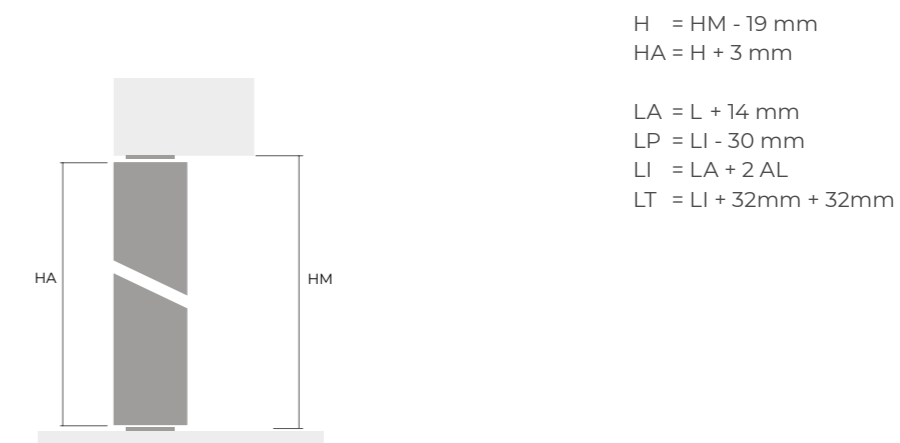

PIVOT LATERALE
lateral axis

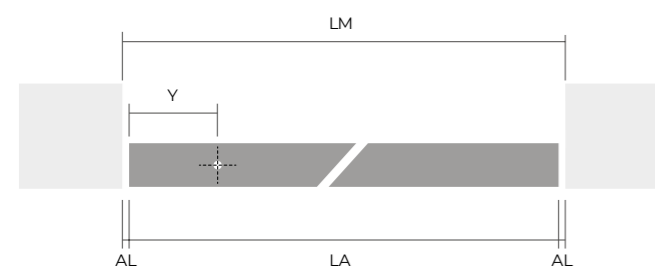

PIVOT CENTRALE
central axis

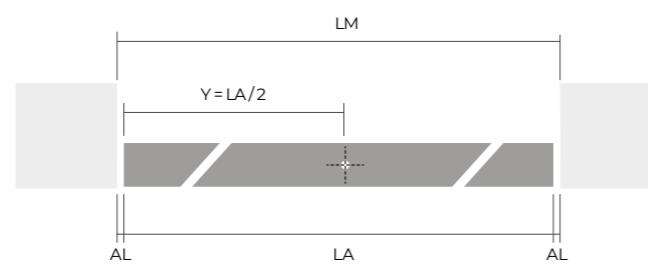

PIVOT LATERALE
lateral axis

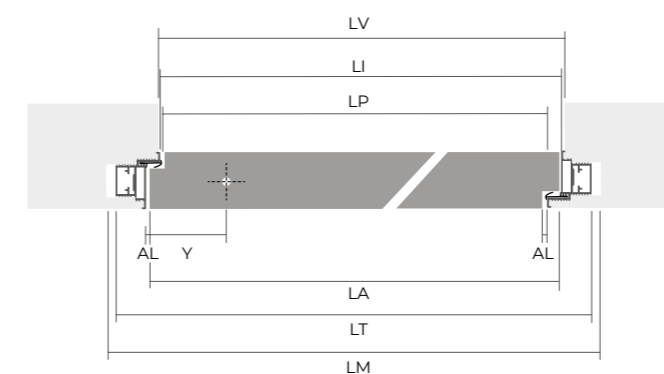

PIVOT CENTRALE
central axis

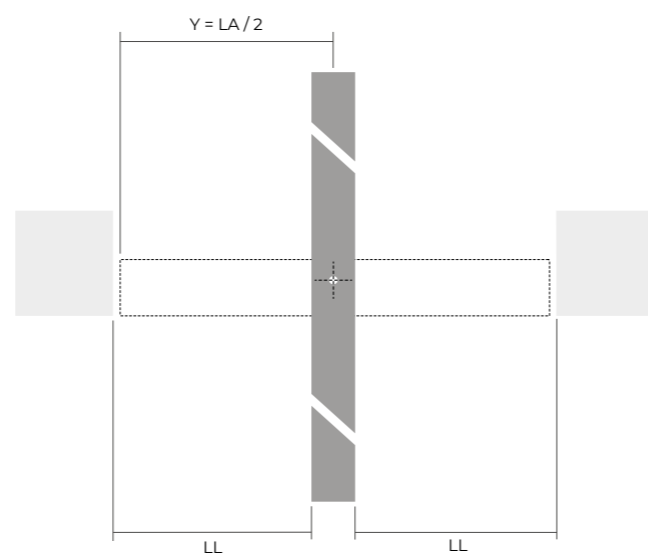
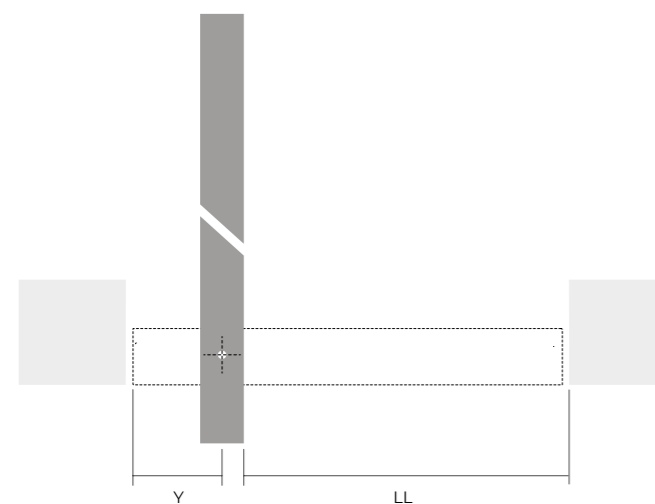
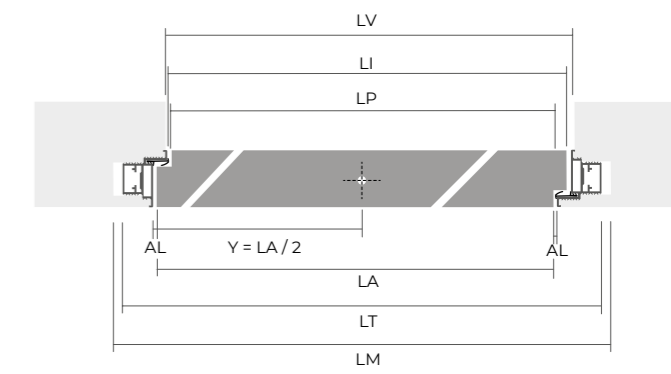

POSIZIONAMENTO PIVOT
pivot positioning

L	Y	AL	LA	LL
LM - 30 mm	40 mm	8 mm	L + 14 mm	LM - Y - AL - 23 mm
LM - 26 mm	80 mm	6 mm	L + 14 mm	LM - Y - AL - 23 mm
LM - 24 mm	120 mm	5 mm	L + 14 mm	LM - Y - AL - 23 mm
LM - 22 mm	120 mm ÷ LA/2	4 mm	L + 14 mm	(LM - 45 mm) / 2

POSIZIONAMENTO PIVOT
pivot positioning

L	Y	AL	LP	LI	LA	LT	LL
LM - 114 mm	40 mm	8 mm	LI - 30 mm	LA + 2 AL	L + 14 mm	LI + 32 + 32	LP - AL - Y - 8 mm
LM - 110 mm	80 mm	6 mm	LI - 30 mm	LA + 2 AL	L + 14 mm	LI + 32 + 32	LP - AL - Y - 8 mm
LM - 108 mm	120 mm	5 mm	LI - 30 mm	LA + 2 AL	L + 14 mm	LI + 32 + 32	LP - AL - Y - 8 mm
LM - 106 mm	120 mm ÷ LA/2	4 mm	LI - 30 mm	LA + 2 AL	L + 14 mm	LI + 32 + 32	(LP - 60 mm) / 2

Scorrevoli a soffitto VOLTA

ceiling sliding door



Binario incassato

concealed rail
rail encastré
carril empotrada
рельс в потолок

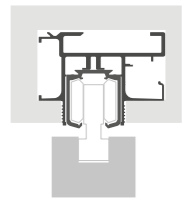

1 BINARIO
1 RAIL

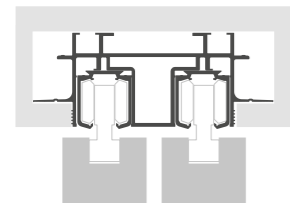

2 BINARI
2 RAILS

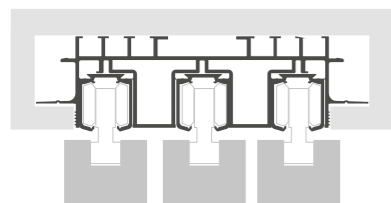

3 BINARI
3 RAILS



Binario a vista

visible pelmet
rail à vue
carril visible
внешний рельс

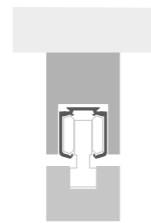

1 BINARIO
1 RAIL

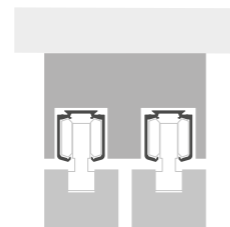

2 BINARI
2 RAILS

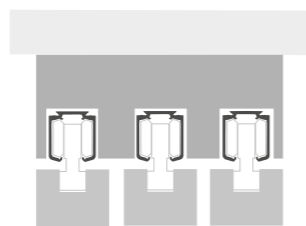

3 BINARI
3 RAILS

Scorrevoli a parete

wall mounted system

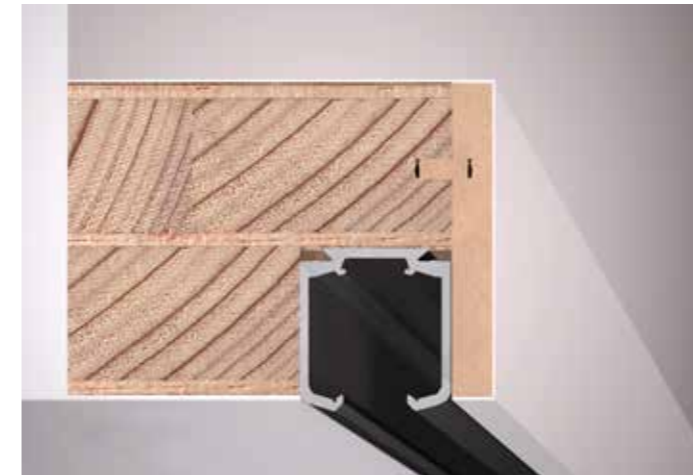

Binario a parete PARI

wall rail
rail à mur
carril a pared
рельс вдоль стены



1 BINARIO
1 RAIL

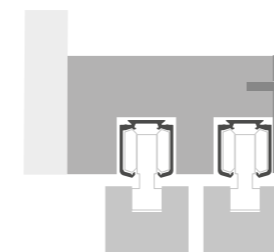

2 BINARI
2 RAILS

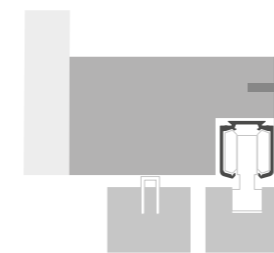

1 BINARIO, 2 VIE
1 RAIL, 2 WAYS



FILA



Scorrevole esterno muro - a parete FILA

barn door with invisible rail - FILA

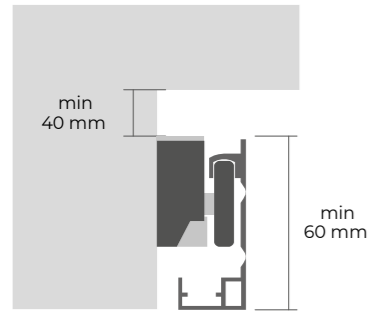

LA = LV + 100 mm
LL = LV - 120 mm
L = LA - 14 mm

LA = LV + 230 mm
LL = LV
L = LA - 14 mm

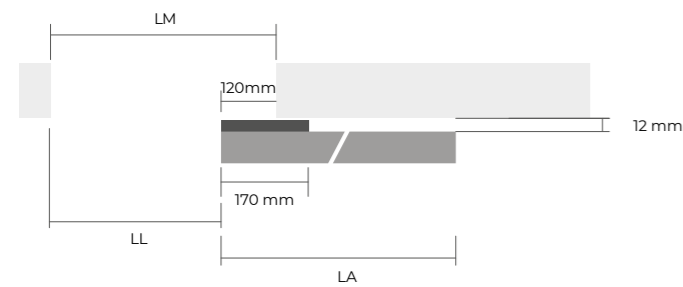

APERTURA PARZIALE
partial opening

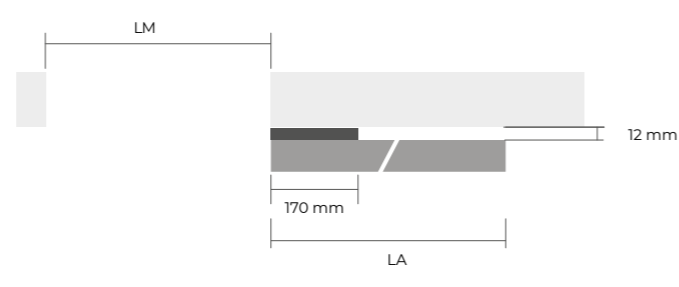

APERTURA TOTALE
total opening

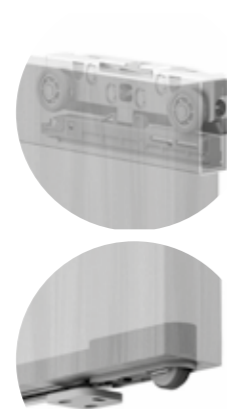
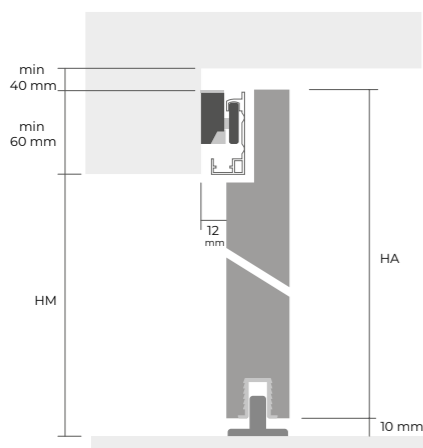
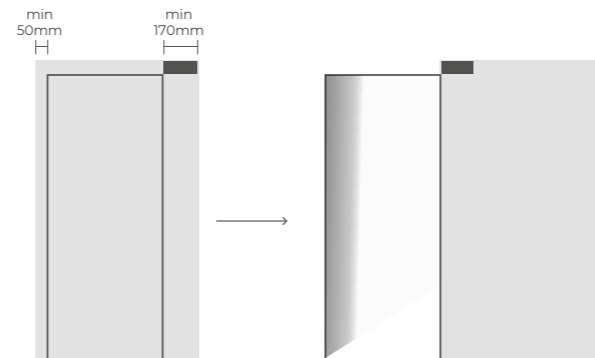
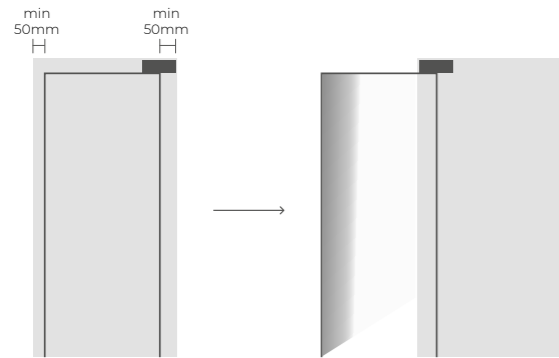

L = larghezza nominale
leaf nominal width
LA = larghezza reale anta
leaf real width
LV = larghezza vano
finished wall width
LM = larghezza foro muro
rough finished wall width
LP = luce passaggio telaio
frame passage width
LT = larghezza telaio
frame width
LC = ingombro coprifili
overall width

Sensi di apertura

direction of opening

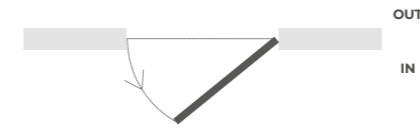

SX / Complanarità a tirare

SX / flush with the wall on the pulling side

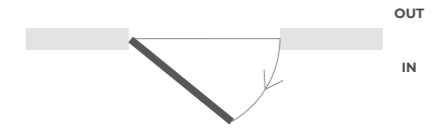

DX / Complanarità a tirare

DX / flush with the wall on the pulling side

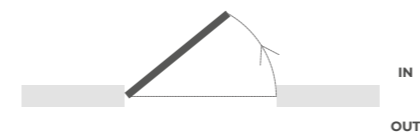

SX / Complanarità a spingere

SX / flush with the wall on the pushing side

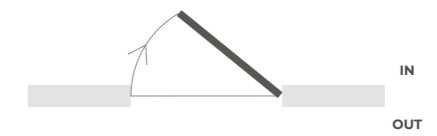

DX / Complanarità a spingere

DX / flush with the wall on the pushing side



FILA S

FILA S



FILA D

FILA D



FILA S

FILA S



FILA D

FILA D

21C108
July 2021

All rights reserved. Reproduction of any part of this document and publication on the internet or any other medium is not permitted without Barausse Srl written permission. The photographic reproduction of the colours, though very similar to reality, should be considered purely indicative.

Barausse Srl reserves the right to make technical or aesthetic modifications and improvements to the products at any time without previous notice. For further information, please visit barausse.com

Credits

Art direction

Studio DLSM Matteo Meraldi

Renderings

Accent Barbiero

Photopiù

Staart Architects

Photos

AK Engineering (74, 75)

La Leta Architettura (16)

Miso Architects (17)

Openini Minsk (12)

Wowdom (54)

Barausse Srl
Via Parmesana 27
36010 Monticello Conte Otto (VI)
Vicenza – Italy

T +39 0444 900 000
info@barausse.com
barausse.com

