

Stylebook

BARAUSSE

04 MADE IN BARAUSSE

12 HIGH STANDARDS

16 BARAUSSE FOR CONTRACT

20 UN'ANTA, MOLTEPLICI SOLUZIONI
one leaf, multiple solutions

22 TIPOLOGIE DI APERTURA
door opening types

26 PORTE IN VETRO & PARTIZIONI
glass doors & partitions

56 PORTE FILOMURO
flush doors

86 MODERNO
moderno collection

110 CLASSICO
classico collection

130 SISTEMA PORTE & BOISERIE
door & wall panelling system

140 MODELLI
models

148 FINITURE
finishing

166 TIPOLOGIE TELAIO
frame types

172 PORTE TECNOLOGICHE
technological doors

Stylebook

BARAUSSE



Index

- | | | | |
|----|---|-----|--|
| 04 | MADE IN BARAUSSE | 86 | MODERNO
Moderno collection |
| 12 | HIGH STANDARDS | 110 | CLASSICO
classico collection |
| 16 | BARAUSSE FOR CONTRACT | 130 | SISTEMA PORTE & BOISERIE
door & wall panelling system |
| 20 | UN'ANTA, MOLTEPLICI SOLUZIONI
one leaf, multiple solutions | 140 | MODELLI
models |
| 22 | TIPOLOGIE DI APERTURA
doors opening types | 148 | FINITURE
finishing |
| 26 | PORTE IN VETRO & PARTIZIONI
glass doors & partitions | 166 | TIPOLOGIE TELAIO
frame types |
| 56 | PORTE FILOMURO
flush doors | 172 | PORTE TECNOLOGICHE
technological doors |

Made in Barausse

Dal 1967 Barausse è specializzata nella produzione di **porte per interni**, 100% progettate e realizzate in **Italia**. Barausse sviluppa e propone soluzioni d'arredo funzionali alla separazione degli spazi, di **alto prestigio** e **valore estetico**, per creare ambienti dove vivere sia un'esperienza emozionante e confortevole. Forte di numerose **certificazioni** per porte resistenti al fuoco, della progettazione di prodotti **custom**, e la trentennale esperienza nel settore **contract**, Barausse opera nel mondo nella realizzazione di Hotel di lusso, strutture pubbliche, costruzioni residenziali e ville private.



Since 1967, Barausse has specialized in the production of interior doors which are 100% designed and manufactured in Italy. Barausse develops and offers furnishing solutions for the purpose of creating a separate space which is both functional and prestigious with a high esthetical value. The result is both a beautiful and comfortable place to live. Thanks to multiple certifications of our fire rated doors, the ability to design bespoke products and our over thirty years of experience in the contract field, Barausse is able to provide worldwide a high quality product for luxury hotels, for public buildings, high end residential and private homes.

Depuis 1967 Barausse est spécialisée dans la production de portes d'intérieur, 100% dessinées et réalisées en Italie. Barausse développe et propose des solutions fonctionnelles à la séparation des pièces, de grand prestige et valeur esthétique, pour créer des environnements où vivre une expérience excitante et confortable. Fort de nombreuses certifications pour portes résistantes au feu, de la conception de produits customisés et de l'expérience trentenaire dans le secteur contract, Barausse opère au niveau mondial dans la réalisation d'hôtels de luxe, structures publiques, constructions résidentielles et villas privées.

Desde 1967 Barausse es especialista en la producción de puertas para el interior, 100% diseñadas y hechas en Italia. Barausse desarrolla y propone soluciones funcionales para la separación de los espacios, de alto prestigio y valor estético, para crear lugares donde vivir sea una experiencia emocionante y confortable. De acuerdo con numerosas certificaciones de puertas resistentes al fuego, con la proyectación de productos a la medida, y con sus treinta años de experiencia en el sector contract, Barausse trabaja en todo el mundo desarrollando hoteles de lujo, estructuras públicas, construcciones residenciales y villas privadas.

С 1967 года Barausse специализируется в области производства дверей 100% спроектированных и реализованных в Италии. Barausse создает и предлагает функциональные интерьерные решения для разделения пространства, престижные и высоко эстетичные. Barausse обладает большое количество сертификатов на противопожарные двери, производит двери по индивидуальным проектам и имеет тридцатилетний опыт работы в сегменте больших проектов. Именно поэтому Barausse работает успешно над созданием интерьеров в гостиницах класса люкс, общественных зданиях, жилых комплексах и частных виллах.

La nostra storia

our history



1967

I fratelli Barausse accolgono la tradizione artigiana di famiglia e fondano l'azienda, che acquisisce in pochi anni una dimensione industriale.

The Barausse brothers embrace the artisan tradition of their family and found the company which rapidly acquires an industrial dimension.

Les frères Barausse embrassent la tradition artisanale de famille et fondent la société qui acquiert rapidement une dimension industrielle.

Los hermanos Barausse acogen la tradición artesanal de familia y fundan la empresa que llega rápidamente a una dimensión industrial.

Братья Barausse, продолжая старинные семейные ремесленные традиции, основали компанию. Быстрый рост превратил компанию в крупное промышленное производство.

1980

Si potenziano i canali distributivi: l'azienda rafforza il mercato interno e inizia la penetrazione di quello estero.

New distribution channels are implemented: the company strengthens the national market and starts penetrating the international market.

De nouveaux réseaux de distribution sont implementés: l'entreprise renforce le marché national et pénètre le marché extérieur.

Se implementan nuevos canales de distribución: la empresa refuerza el mercado nacional y empieza la penetración del mercado exterior.

Началась работа на новых каналах сбыта: Компания укрепляет свои позиции на внутреннем рынке и начинает проникновение на международный.

1990

Barausse è il primo produttore certificato ISO 9002. Le certificazioni di resistenza al fuoco aprono al mercato alberghiero.

Barausse is the first ISO 9002 certified manufacturer. The certifications of fire resistance open the Hotel market.

Barausse est le premier producteur certifié ISO 9002. Les certifications de résistance au feu ouvrent au marché de l'hôtellerie.

Barausse es el primero productor certificado ISO 9002. Las certificaciones de resistencia al fuego abren al mercado hotelero.

Barausse это первый производитель, получивший сертификат ISO 9002. Наличие противопожарных сертификатов открыло дорогу на рынок гостиничных дверей.

2000

Barausse crea la Divisione Contract e sviluppa la prima collezione alluminio. L'azienda si dota di un sistema logistico all'avanguardia.

Barausse creates the Contract Division and designs its first aluminum collection. The company adopts an advanced logistics system.

Barausse crée la Division Contract et présente sa première collection en aluminium. L'entreprise s'équipe avec un système logistique évolué.

Barausse crea el Dep. Contract y presenta la primera colección aluminio. La empresa se equipa con un sistema logístico avanzado.

Организовано Гостиничное подразделение и развивает первую коллекцию алюминия. Запускается новейшая система управления логистикой.

2010

Barausse potenzia la struttura organizzativa e rafforza la presenza commerciale con l'apertura di filiali in Italia e all'estero.

Barausse improves its organizational structure and strengthens its presence with subsidiaries worldwide in support of the distribution network.

Barausse développe la structure de l'organisation et renforce sa présence avec filiales dans le monde pour supporter la distribution.

Barausse potencia la estructura organizativa y desarrolla su presencia con creación de filiales de venta en el mundo.

Barausse усиливает организационную структуру. Открывая филиалы, компания усиливает собственное присутствие в Италии и за рубежом.

2020

Barausse è partner prescelto per rinomati progetti nel mondo. L'azienda migliora i processi applicando i principi della produzione Lean.

It is a chosen partner for renowned projects in the world. The company improves the processes by applying the principles of the Lean Production.

Barausse est sélectionné pour renommés projets dans le monde. L'entreprise améliore les processus en appliquant les principes de la production Lean.

Barausse es elegido para proyectos renombrados en el mundo. La empresa mejora los procesos aplicando los principios de la producción Lean.

Barausse становится надежным партнером многих известных мировых проектов. Компания улучшает процессы, применяя принципы Lean Production.

Design e funzionalità

design and functionality

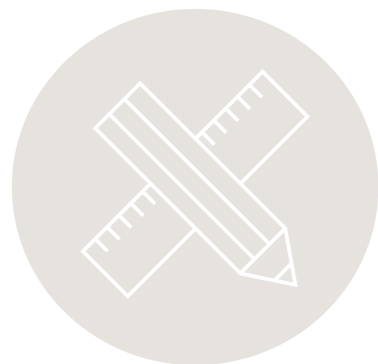

Personalizzazione

Barausse è organizzata per rispondere alle specifiche esigenze dei clienti con prodotti altamente personalizzati.

Nuove soluzioni

La ricerca di nuove soluzioni è mirata al continuo miglioramento della funzionalità di prodotto per garantire ambienti confortevoli da vivere.

Porte tecnologiche

Le porte sono realizzabili con caratteristiche di resistenza al fuoco garantite da certificazioni internazionali.

Costumization
Barausse is organised to provide highly customized models in line with the style desired by our costumers.

Personnalisation
Barausse est organisée pour répondre aux exigences spécifiques des clients avec des produits hautement personnalisés.

Personalización
Barausse está organizada para satisfacer las específicas exigencias de los clientes gracias a productos personalizados.

Индивидуализация
Наша компания организована для того, чтобы реализовать индивидуальные модели в соответствии с желанием клиентов.

New solutions
The research of new solutions focuses on the constant improvement of the product features in order to ensure comfortable spaces.

Nouvelles solutions
La recherche de nouvelles solutions est visée à l'amélioration continue de la fonctionnalité du produit pour garantir des espaces confortables.

Nuevas soluciones
La búsqueda de nuevas soluciones aspira a la continua mejoría de la funcionalidad de los productos para garantizar unos ambientes cómodos.

Новые решения
Поиск новых решений целится в постоянное улучшение функций товаров для создания уютного пространства.

Technological doors
Doors are available in the fire resistant version guaranteed by International certificates.

Portes technologiques
Les portes sont réalisables en version résistante au feu, garantie par certifications internationales.

Puertas tecnológicas
Las puertas son disponibles en versión resistente al fuego y son garantizada por certificaciones internacionales.

Технологические двери
Двери возможны с применением противопожарной технологий, сертифицированной международными сертификатами.

Affidabilità

reliability



Resistenza

Cerniere e serrature testate e certificate dal produttore per oltre 200.000 aperture e per la resistenza alla corrosione.

Durabilità

Utilizzo di materiali certificati, trattati per la stabilizzazione e la durabilità.

Qualità certificata

Certificazione del Sistema Qualità per la Gestione Aziendale conforme alla normativa UNI EN ISO 9001.

Resistance
Hinges and locks are tested and certified by the manufacturer for over 200.000 openings and for corrosion resistance.

Résistance
Charnières et serrures testées et certifiées par le producteur pour 200.000 ouvertures et pour la résistance à la corrosion.

Resistencia
Bisagras y cerraduras testeadas y certificadas por el fabricante para más de 200.000 aberturas, y para la resistencia a la corrosión.

Прочность
Петли и замки протестированы и сертифицированы производителем с гарантией на 200.000 открытий и на устойчивость к коррозии.

Durability
We use certified products, which are treated to ensure stabilization and durability.

Durabilité
Utilisation de matériaux certifiés qui sont traités pour la stabilisation et la durabilité.

Durabilidad
Empleo de materiales certificados desarrollados para asegurar la estabilización y la durabilidad.

Долговечность
Мы используем сертифицированные материалы произведены в Италии или в Германии. Они обработаны для того чтобы гарантировать стабилизацию и долговечность.

Certified quality
Quality Management System Certification according to the UNI EN ISO 9001 standards.

Qualité certifiée
Certification du Système de Gestion de la Qualité conforme à la réglementation UNI EN ISO 9001.

Calidad certificada
Certificación Sistemas de Gestión de la Calidad según las normas UNI EN ISO 9001.

Сертифицированное качество
Сертификат Системы Качества для Управления Предприятием в соответствии с нормами UNI EN ISO 9001.

Comfort

comfort



Piacere d'uso

Tutti i componenti, dal telaio alla serratura, vengono orchestrati per rendere maneggevoli le fasi di apertura e chiusura.

Silenziosità

La speciale geometria e la morbidezza della guarnizione limitano il passaggio della luce e migliorano l'isolamento di rumori.

Comfort certificato

Per maggiori performance acustiche si realizzano porte con isolamento acustico certificato fino a 41 dB.

Accuratezza logistica

logistics accuracy



Etichettatura personalizzata

Ogni collo è identificato da un'etichetta riportante tutte le informazioni, incluso il posizionamento.

Scelta accurata dell'imballo

La trentennale esperienza nella spedizione delle nostre porte nel mondo si traduce nella scelta di imballi resistenti e massima accuratezza nell'ottimizzazione degli spazi.

Tracciabilità

Gestione documentale dettagliata disponibile tramite il portale dedicato.

Enjoyable use

Each component, from the frame to the lock, is armonised to make the opening and closure phases as manageable as possible.

Plaisir d'usage

Tous les composants, du châssis à la serrure, sont orchestrés pour rendre les phases d'ouverture et fermeture maniables.

Empleo agradable

Todos los componentes, desde el marco hasta la cerradura, son armonizados entre ellos para que las fases de apertura y cierre sean manejables.

Приятно в использовании

Каждый элемент, от короба до замка, приведён в соответствие для того чтобы сделать фазы открытия и закрытия управляемыми.

Silence

Light transition and soundproofing are improved by the peculiar geometry and the smoothness of the gasket.

Silence

La géométrie spéciale et la douceur du joint limitent le passage de la lumière et ils améliorent l'insonorisation des bruits.

Silencio

La especial geometría y la suavidad de la junta limitan el paso de la luz y mejoran el aislamiento acústico

Бесшумность

Особая геометрия и мягкость уплотнения ограничивают проникновение света и улучшают звукоизоляцию.

Certified comfort

For better acustic performances Barausse realizes acoustical insulating doors certified up to 41 dB.

Confort certifié

Pour des meilleures performances acoustiques on réalise aussi des portes avec insonorisation acoustique certifiée jusqu'à 41 dB.

Confort certificado

Para mejores performance acústicas se ofrecen puertas con aislamiento acústico certificado hasta 41 dB.

Сертифицированный комфорт

Для высшего уровня акустической изоляции мы реализуем звукоизоляционные двери сертифицированы до 41 децибел.

Personalized labels

Each box is identified with a label that contains all the pertinent information, including positioning.

Étiquetage personnalisé

Chaque colis est identifié par une étiquette sur laquelle figurent toutes les informations, positionnement compris.

Etiquetado personalizado

Cada paquete está identificado por una etiqueta con toda la información, incluida la posición.

Персонализированное этикетирование

Каждое грузовое место обозначается этикеткой, на которой указана вся информация, включая позиционирование.

Attentive choice of packaging 30 years

of experience in delivering our doors all over the world has enabled us to have a selection of resistant packaging and the highest precision in optimizing spaces.

Choix méticuleux de l'emballage

30 ans d'expérience dans l'expédition de nos portes dans le monde entier se traduisent par le choix d'emballages résistants et par le plus grand soin accordé à l'optimisation des espaces.

Cuidadosa elección del embalaje

Los más de 30 años de experiencia en el envío de nuestras puertas por todo el mundo se traducen en la elección de un embalaje resistente y la máxima precisión en la optimización del espacio.

Тщательный выбор упаковки

Тридцатилетний опыт отгрузки наших дверей в различные страны мира помогает нам в выборе прочной упаковки и обеспечении максимальной точности для оптимизации пространств.

Traceability

Detailed document management available through our dedicated portal.

Trazabilidad

Gestión documental detallada disponible a través de un portal específico.

Traçabilité

Gestion des documents détaillée et disponible via un portail dédié.

Отслеживаемость

Детальное управление документацией с помощью специального портала.

High standards

Macchinari altamente automatizzati consentono precisione nella realizzazione dei prodotti e puntuale monitoraggio del processo. All'interno di ogni porta viene inserita un RFID per il tracciamento e la rilevazione automatica dei dati di produzione.



Highly automated machines allow us to obtain high precision during production and careful monitoring of all processes. An RFID tag is inserted into each door to ensure traceability and permit production data to be read automatically.

Des machines hautement automatisées sont gage de précision dans la réalisation des produits et de monitoring précis du processus. Un RFID est ajouté à chaque porte pour tracer et relever automatiquement les données de production.

Riempitivo personalizzabile a seconda delle necessità: alveolare, truciolare forato, pannelli fonoisolanti o termoisolanti.

Custom filling based on the requirements: honeycomb, perforated chipboard, thermoinsulating panel or soundproof panel.

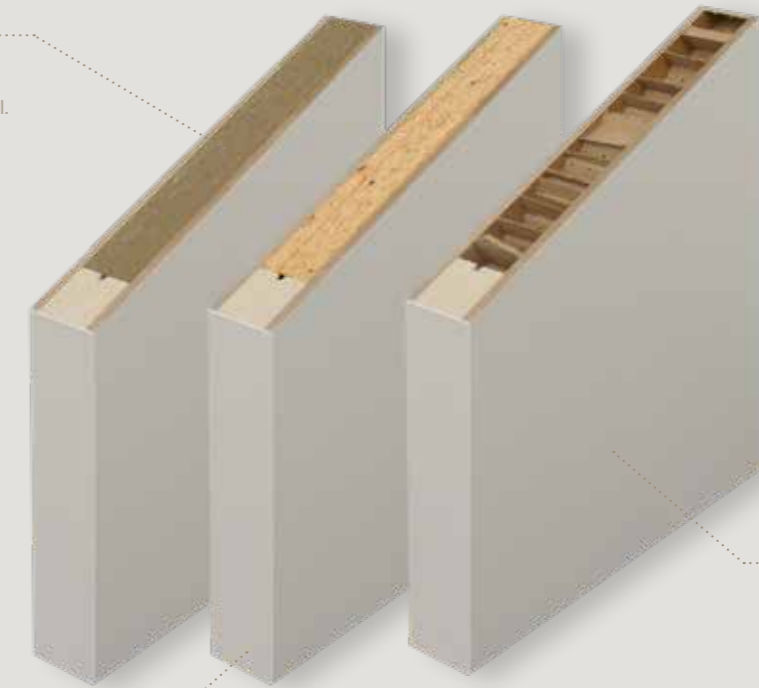

Anta con struttura di abete di ampia sezione e rivestimento in HDF da 6 mm a bassa emissione di formaldeide che garantisce stabilità, resistenza all'urto e solidità.

Leaf with a wide-section of fir perimetric structure and a 6 mm HDF covering which ensure stability, impact resistance and solidity.

I bordi dell'anta sono abbinati alle "facce" per un elegante effetto di continuità. In particolare, la bordatura inferiore protegge l'anta dall'assorbimento di umidità da pavimenti umidi.

Leaf edges are coordinated with the leaf surface to give an elegant effect of continuity. In particular, the lower edge protects leaf from absorption of floor humidity.

10+

Certificazioni internazionali
International certifications

18

Brevetti industriali
Industrial patent

Nuestra maquinaria altamente automatizada permite la precisión en la fabricación de nuestros productos y una monitorización precisa del proceso. En el interior de cada puerta se introduce una etiqueta RFID para realizar un seguimiento y registro automático de los datos de fabricación.

Высокоавтоматизированное оборудование обеспечивает точность при изготовлении изделий и тщательный мониторинг процесса. В каждую дверь устанавливается РЧ-идентификатор для отслеживания и автоматического считывания производственных данных.

Green

Tutte le linee di prodotto sono realizzate rispettando parametri di qualità e certificazioni specifiche per il rispetto dell'ambiente e della salute. Le nostre porte sono realizzate con pannelli a bassa emissione di formaldeide, conformi alla normativa CARB2/TSCA cat.6. Legni e decorativi sono privi di sostanze tossiche, le laccature sono finite con vernici all'acqua, e gli incollaggi avvengono solo con colle viniliche senza emissione di formaldeide.



All our product lines are made in compliance with quality parameters and specific environmental protection and health safety certifications. All our doors are made of low formaldehyde emission panels, compliant with the CARB2 / TSCA cat.6 standard. Decorative elements are free of toxic substances, lacquers are finished with water-based paints, and gluing takes place only with vinyl glues without formaldehyde emission.

Toutes les lignes de produits sont réalisées en respectant des paramètres de qualité et des certifications spécifiques de respect de l'environnement et de la santé. Toutes nos portes sont fabriquées avec des panneaux à faible émission de formaldéhyde, conformes à la norme CARB2 / TSCA catégorie 6. Les éléments décoratifs sont exempts de substances toxiques, les laques sont finies avec des peintures à l'eau et le collage se fait uniquement avec des colles vinyliques sans émission de formaldéhyde.



ISO 14001

Sistema gestione ambientale
Environmental management

ISO 9001

Sistema qualità
Quality management

Todas las líneas de productos se fabrican respetando los parámetros de calidad y las certificaciones específicas para el respeto del medio ambiente y la salud. Todas nuestras puertas están fabricadas con paneles de baja emisión de formaldehído, cumpliendo con la norma CARB2 / TSCA cat. 6. Las decoraciones están libres de sustancias tóxicas, las lacas tienen un acabado con pinturas al agua y el pegado se realiza únicamente con colas vinílicas sin emisión de formaldehído.

Все линейки продукции изготавливаются с соблюдением параметров качества и сертификаций по охране окружающей среды и здоровья. Все наши двери изготовлены из панелей с низким уровнем выделения формальдегида, соответствующих стандарту CARB2 / TSCA cat. 6. Декоры не содержат токсичных веществ, лакированные поверхности обрабатываются вододисперсионными лаками, а для склеивания применяются только не выделяющие формальдегид виниловые клеи.

Barausse for Contract

Forte di numerose certificazioni per porte resistenti al fuoco e fonoisolanti, della progettazione di prodotti custom e la trentennale esperienza nel settore contract, Barausse opera nel mondo nella realizzazione di Hotel di lusso, strutture pubbliche, costruzioni residenziali e ville private.

Thanks to multiple certifications of our fire rated and soundproof doors, the ability to design bespoke products and our over thirty years of experience in the contract field, Barausse is able to provide worldwide a high quality product for luxury hotels, for public buildings, high end residential and private homes.

Fort de nombreuses certifications pour portes résistantes au feu et acoustiques, de la conception de produits customisés et de l'expérience trentenaire dans le secteur contract, Barausse opère au niveau mondial dans la réalisation d'hôtels de luxe, structures publiques, constructions résidentielles et villas privées.

De acuerdo con numerosas certificaciones de puertas resistentes al fuego y acústicas, con la proyectación de productos a la medida, y con sus treinta años de experiencia en el sector contract, Barausse trabaja en todo el mundo desarrollando hoteles de lujo, estructuras públicas, construcciones residenciales y villas privadas.

Barausse обладает большое количество сертификатов и на противопожарные и на звукоизоляционные двери, производит двери по индивидуальным проектам и имеет тридцатилетний опыт работы в сегменте больших проектов. Именно поэтому Barausse работает успешно над созданием интерьеров в гостиницах класса люкс, общественных зданиях, жилых комплексах и частных виллах.



Supporto al partner nell'elaborazione dell'abaco

Support to the partner in the elaboration of the bill of quantity

Soutien au partenaire dans la préparation de l'offre

Помощь пратнеру в подготовке оферты

Analisi del progetto in funzione dei requisiti richiesti

Project analysis in terms of performance requirements

Analyse du projet selon les exigences

Анализ проекта на соответствие всем требованиям

Ricerca delle tecnologie appropriate

Research of the most appropriate technologies

Recherche des technologies appropriées

Подбор надежных технических решений

Elaborazione delle soluzioni adeguate nel rispetto dei budget

Elaboration of adequate solutions within the customer's budget

Élaboration des solutions appropriées en conformité avec le budget

Подбор решений в соответствии с бюджетом заказчика

Project engineering ed elaborazione di shop drawings

Project engineering and elaboration of shop drawings.

Ingénierie du project et élaboration des shop drawings.

Проектный инжиниринг и полный комплекс проектных работ

Collaudo del prodotto

Product testing

Test de produit

Испытания и тестирования

Assistenza e formazione in cantiere

Customer service and training on site

Assistance et formation sur place

Сопровождение и обучение подрядчиков

Gestione rapida degli imprevisti di cantiere

Prompt management of building site unexpected problems

Gestion rapide des imprévus en chantier

Мгновенное реагирование на новые обстоятельства, связанные с проектом

Barausse worlwide

- Hospitality
- Home
- Office
- Wellness
- Healthcare
- Others



- Algeria**
 - Marriott Hotel, Constantine
 - Sheraton Hotel, Algeri
 - Renaissance Tlemcen Hotel, Tlemcen
 - Marriott Complex, Algeri
 - CIC - Centre International Congress, Algeri
- Croatia**
 - BPK Villas, Dubrovnik
- Cyprus**
 - Ayia Napa Marina
 - Marina Limassol
- France**
 - Hyatt Paris Madeleine, Paris
 - Nespresso Store, Rennes

- Greece**
 - Romanos Project, Navarino
- Honk Kong**
 - The Henley, Honk Kong
- Italy**
 - Hilton Molino Stucky, Venice
 - Hotel Moresco, Venice
 - Marina di Venezia, Venice
 - Hotel Terme Miramonti, Montegrotto
 - Grand Hotel Mont Blanc, Courmayeur
 - Verdura Int. Golf & SPA Resort, Sciacca
 - Porto Piccolo, Sistianna
 - IBM executive Center, Rome
 - Dolce&Gabbana Headquarter, Florence
 - Paradise SPA, Verona

- Hospital, Merano
- Falisia Medical Center, Sistianna
- Yachting Club, Porto Cervo
- Japan**
 - Sumitomo Building Residence, Tokyo
 - Terrace Ebisu Residence, Tokyo
 - Ayohama Rise Residence, Tokyo
- Lithuania**
 - Magnum business center, Kaunas
- Malta**
 - Hyatt Regency Hotel, St Julian's
- Mongolia**
 - Khan Hills Residence, Ulan Bator

- Montenegro**
 - Hotel Perla, Hergi Novi
- Netherlands**
 - Rotterdam Navy Hotel, Rotterdam
- Nigeria**
 - Townhouses at Lekki, Lagos
- Qatar**
 - Al Majda Farm Villa, Qatar
- Panama**
 - La Maison by Fendi, Panama

- Russia**
 - Hyatt Regency Park Hotel, Moscow
 - InterContinental Tverskaya, Moscow
 - Four Seasons Hotel, Moscow
 - Swiss Hotel, Sochi
 - Gazprom offices, Saint Petersburg
 - Calzedonia HQ and Apartments, Moscow
 - Cloud Nine, Moscow
- Senegal**
 - Radisson Blu Hotel, Dakar
- Serbia**
 - Sakura Park, Belgrade

- Switzerland**
 - Grand Hotel Kempinski SPA, Geneva
 - Nespresso Store, Geneva
 - Parco Lago, Lugano
- United Kingdom**
 - Cathedral Yard, Exeter
- USA**
 - Brickell Flatiron, Miami
 - Sunset Lake Residencies, Fort Lauderdale
 - Chelsea Condo, New York
 - Adagio Fort Lauderdale Beach, Fort Lauderdale
 - La Clara, West Palm Beach
 - Presbyterian Hospital, New York
 - Russian Embassy, New York

One leaf, multiple solutions

Un'anta,
molteplici soluzioni



Tipologie di apertura

door opening types

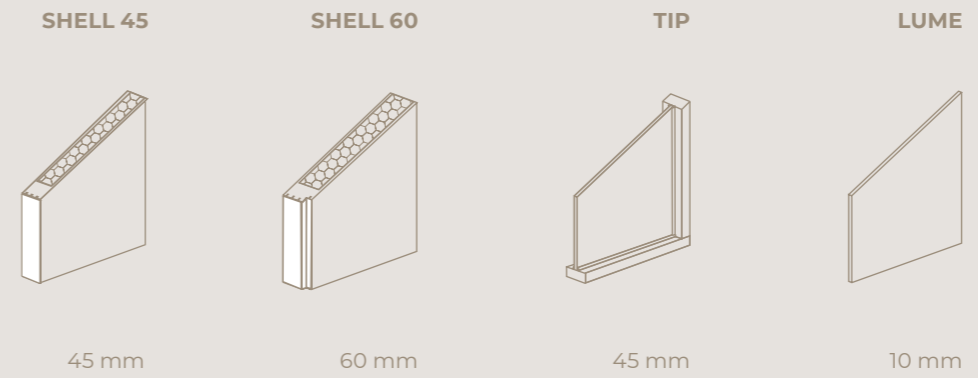
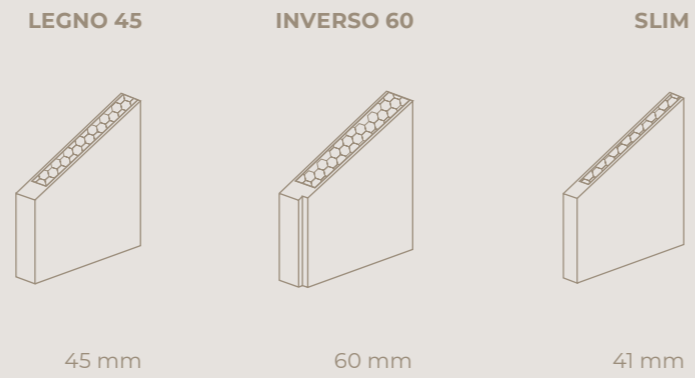

		LEGNO 45	INVERSO 60	SLIM
Battente Hinged	telaio rasomuro flush frame	●	●	----
	telaio alluminio aluminum frame	●	●	----
	telaio legno wooden frame	●	●	----
Bilico Pivot	con battuta with SECRET frame	----	●	----
	senza battuta with no frame	●	----	----
Rototraslante Sliding pivot	telaio legno wooden frame	●	----	----
Libro Bifold	telaio legno wooden frame	●	----	----
Scorrevole a scomparsa Pocket	con telaio standard pocket	●	----	----
	rasomuro flush pocket	●	----	●
Scorrevole a parete Barn	con binario invisibile FILA with invisible rail - FILA	●	----	----
	con binario a vista PARI wall mounted system PARI	●	----	----
Scorrevole a soffitto Ceiling sliding	con binario incassato VOLTA concealed rail - VOLTA	●	----	----
	con binario a vista VOLTA visible pelmet - VOLTA	●	----	----

		SHELL 45	SHELL 60	TIP	LUME
		●	●	●	●
		●	●	●	●
		●	●	●	●
		●	●	●	----
		----	----	●	----
		----	----	----	----
		----	----	In progress	----
		●	----	●	●
		●	----	●	●
		●	----	----	●
		●	----	●	----
		●	----	●	----

Apertura battente

hinged doors opening
ouverture des portes battantes
apertura de puertas batientes
виды распашных дверей



con telaio a vista

with visible frame
avec cadre visible
con marco visible
с видимой рамкой



con telaio rasomuro

with flush frame
cadre ras du mur
marco a ras de la pared
короб в обрез стены

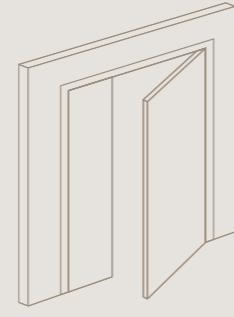

anta doppia

double leaf
porte double
hoja doble
двустворчатое полотно

Apertura bilico

pivot door
porte pivotante
puerta pivotante
pivot дверь

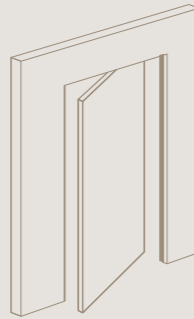

con telaio rasomuro SECRET

with SECRET frame
avec cadre SECRET
con marco SECRET
с рамкой SECRET

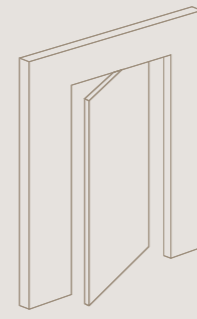

senza battuta

frameless
sans cadre
sin marco
без рамки

Aperture speciali

special opening
ouvertures spéciales
aperturas especiales
специальные открывания

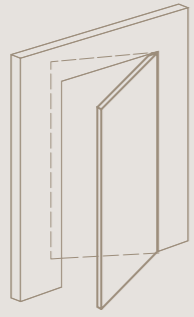

a vento

swing door
porte va-et-vient
puerta vaivén
качающаяся двери

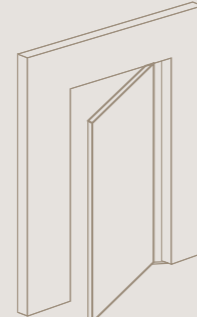

rototraslante

sliding pivot door
porte pivotante-coulissante
puerta rototraslante
дверь с ротомеханизмом

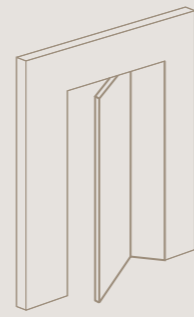

a libro

bifold door
porte pliante
puerta a libro
Дверь книжка

Apertura scorrevole

sliding doors solutions
solutions coulissantes
soluciones para puertas correderas
виды раздвижных дверей

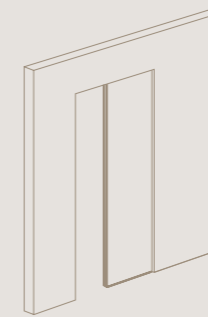

scorrevole a scomparsa

flush pocket door
porte coulissante rétractable
puerta corredera interior
Раздвижные в пенал без
обрамления проема

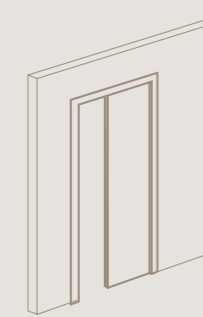

scorrevole a scomparsa con telaio

standard pocket door with frame
porte coulissante rétractable
avec cadre
puerta corredera interior con marco
Раздвижные двери с
обрамлением проема

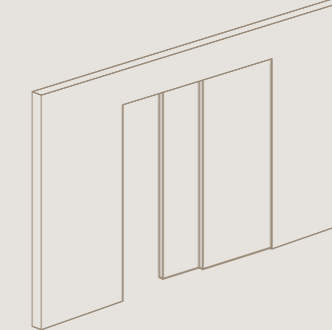

VOLTA con binario incassato

with concealed rail
avec rail de guidage encastré
con guía empotrada en el techo
с потолочным встраиваемым
рельсом

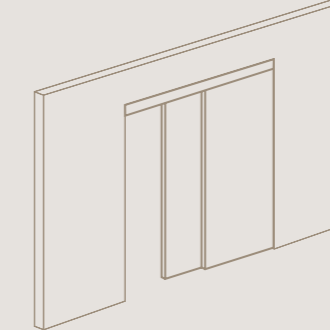

VOLTA con binario esterno

with visible pelmet
avec rail de guidage externe
con guía externa
потолочная раздвижная дверь
с внешним рельсом

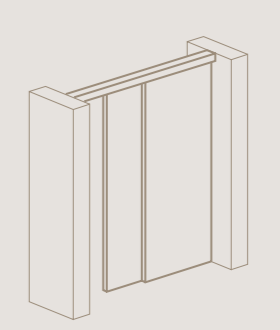

VOLTA con binario esterno, in nicchia

with visible pelmet, in niche
avec rail de guidage externe, en niche
con guía externa, en nicha
потолочная раздвижная дверь
с внешним рельсом в проеме

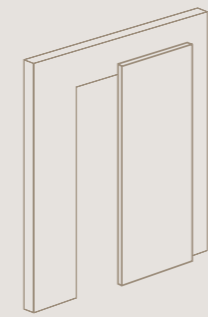

scorrevole esterna FILA

barn door with invisible track
porte coulissante le long d'un mur
puerta corredera externa
раздвижная вдоль стены

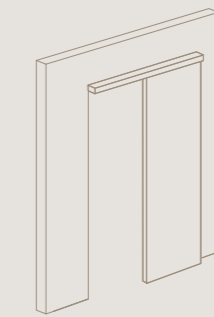

PARI con mascherina

PARI with pelmet
PARI avec élément masquant
PARI con cubre guía
PARI с декоративным наличником

Porte in vetro & partizioni







CARBON TIP 60,
CARBON TIP 130,
SS FUMÉ



Il traversino maniglia è completamente integrato nel design dell'anta ed enfatizzato da uno spessore maggiore rispetto ai traversini decorativi per dare un invito all'utilizzo.

The handle crossbar is completely integrated on the leaf design and stands out for its greater thickness than the decorative ones, almost as an invitation to use.

CARBON TIP I30,
SS FUMÉ





Battenti TIP

TIP hinged doors



TIP 60



TIP L1



TIP I30



TIP O90



TIP G4



TIP G5



Telai alluminio

aluminum frames



SECRET_La massima espressione di essenzialità. Il telaio invisibile filomuro SECRET, coniuga il know-how Barausse con la ricerca stilistica attenta a proporre soluzioni innovative.

SECRET_The highest expression of essentiality. SECRET flush invisible frame combines Barausse know-how with stylistic research for innovative solutions.



INNER X1_Variante del nostro telaio filomuro caratterizzata da un profilo a vista che incornicia ed impreziosisce l'anta, disponibile in tutte le finiture METAL.

INNER X1_A variant of our flush frame characterized by a visible profile that embellishes the door, it is available in any METAL finishing.



INNER2_Telaio minimal che non richiede opere murarie. Caratterizzato dalla presenza di un coprifilo su un lato, disponibile in tutte le finiture METAL.

INNER2_This minimal frame does not require any masonry work for installation. It is characterized by a joint cover on one side, and it is available in any METAL finishing.

Scorrevoli TIP

TIP sliding doors

CARBON TIP I30,
SS FUMÉ,
POCKET DOOR



CARBON TIP I30,
SS FUMÉ,
WALL MOUNTED SLIDING DOOR





Una tipologia di porta battente di grande pregio: le porte a bilico TIP sono il risultato di un'attenta ricerca stilistica volta ad ottenere un'anta esile ma d'impatto. Perfettamente integrabili nell'arredo, grazie anche alla varietà dei modelli anta, riescono a scandire e al tempo stesso amalgamare la distribuzione interna degli spazi. Configurabile in anta singola o multipla, rende gli ambienti molto scenografici.

A type of hinged door of great value: TIP swing doors are the result of careful stylistic research aimed at obtaining a slender yet striking door. Perfectly integrable with the furniture, thanks to the variety of door models available, it both punctuates and amalgamates the internal distribution of space. Available both as a single and as a multiple door, it adds a scenic touch of to any room.

Un tipo de puerta batiente de gran valor: las puertas batientes TIP son el resultado de una cuidadosa investigación estilística destinada a obtener una puerta esbelta pero impactante. Perfectamente integradas en el mobiliario, gracias a la variedad de modelos de puertas, pueden explorar y al mismo tiempo amalgamar la distribución interna del espacio. Configurable en puertas simples o múltiples, hace que las habitaciones sean muy pintorescas.

Un type de porte à charnières de grande valeur: les portes battantes TIP sont le résultat d'une recherche stylistique minutieuse visant à obtenir une porte élancée mais percutante. Parfaitement intégrés au mobilier, grâce à la variété des modèles de portes, ils peuvent scanner et en même temps fusionner la répartition interne de l'espace. Configurable en vantail simple ou multiples, il rend les pièces très pittoresques.

Тип распашной двери с высокими эстетическими качествами: поворотные двери TIP - это результат тщательной стилистической проработки, направленной на получение лёгкой, но эффектной створки. Они прекрасно вписываются в интерьер, в том числе благодаря разнообразию моделей створок, и способны подчёркивать и в то же время сглаживать зонирование пространства. Возможность конфигурации в виде одиночной или множественной створки делает пространство более впечатляющим.





RAME TIP I30,
MATER BRONZO M2



Vetro Mater Bronzo M2 con all'interno una rete
metallica bronzata

Mater Bronzo M2 Glass with bronzed metal
mesh inside







BRONZE TIP 60,
SS BRONZO



La massima espressione minimalista dell'anta vetro e alluminio Barausse. Ampie superfici vetrate incorniciate in un sottile profilo di alluminio personalizzabile in diverse finiture per meglio adattarsi ad ogni tipo di ambiente. TIP 60 rappresenta la versione più semplice dell'anta ottenuta dall'unione dei due materiali.

The utmost minimalist expression of the Barausse glass and aluminium door. Large glass surfaces framed in a thin aluminium profile can be customized in different finishes to better adapt to any type of environment. TIP 60 is the most simple version of the door, obtained by combining the two materials.



Flush doors

Porte filomuro



SECRET è la linea di porte filomuro che garantisce modernità e personalizzazione in ogni ambiente. Il telaio invisibile e l'anta realizzabile in infinite tonalità laccate, essenze legnose e finiture materiche, sono pensati appositamente per adattarsi a qualsiasi spazio. Una porta dal minimo impatto estetico da scoprire anche nella versione YOU tintegegiabile, abbinata al battiscopa filomuro, scorrevole o nella sua versione resistente al fuoco e fonoisolante.

SECRET is the flush door collection that allows customization and guarantees modernity in every environment. Its innovative frame and the customizable leaf, available in unlimited finishes, shades and wood veneers, are specifically designed to adapt perfectly to all spaces. A door with minimal design available also in the sliding version, combined with the flush wall skirting board or in its fire-resistant and sound-insulating option.

SECRET est la gamme de portes affleurantes qui garantit modernité et personnalisation dans tous les environnements. Le cadre invisible en aluminium et le vantail disponible dans différentes finitions lacquées, une gamme infinie des nuances et essences de bois, sont conçus spécifiquement pour s'adapter parfaitement à vos espaces. Une porte à l'impact esthétique minimal à découvrir également dans la version YOU à peindre, combinée à la plinthe ras du mur et éventuel boiserie. Porte disponible aussi en version coulissante, coupe-feu et insonorisante.

SECRET es una línea de puertas a ras de pared que garantiza modernidad y personalización en cada ambiente. El marco innovador y la hoja realizable en varios materiales y acabados son pensadas especialmente para adaptarse perfectamente a tus espacios. Una puerta que también está en versión corredera, en combinación con el zócalo a ras de pared o en su versión resistente al fuego y acústica.

SECRET – это серия скрытых дверей, гарантирующих современный вид и индивидуальность в любой обстановке. Инновационные короб и полотно, представленное в различных материалах отделки, оттенках и видах древесины, специально разработаны, чтобы идеально соответствовать вашему пространству. Дверь с минимальным эстетическим воздействием также предлагается в отделке YOU под покраску, в сочетании со скрытым плинтусом, в раздвижной версии или в версии с повышенной огнестойкостью и звукоизоляцией





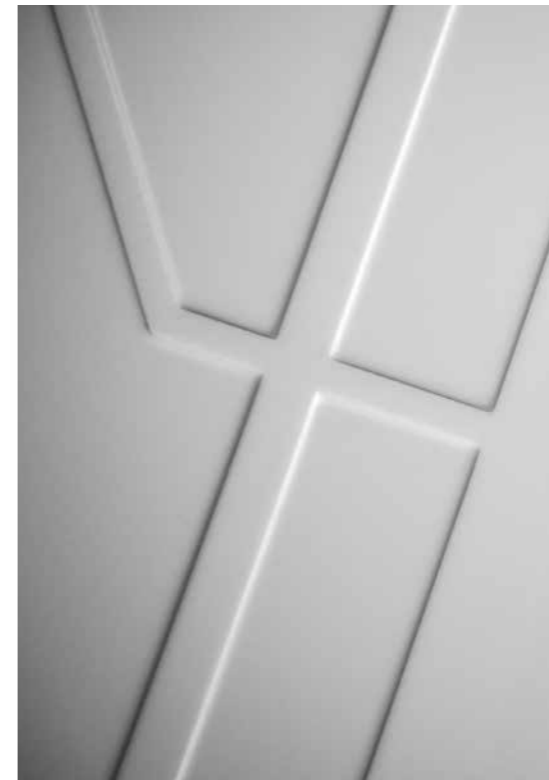

Articolate ed evocative, segnate da una forte cifra stilistica, le pantografature, donano personalità all'ambiente.

Articulate and evocative, with strong aesthetics design, pantographs gives personality to the architectures.



L'innovativa laccatura METAL dona anche alla semplice anta piana una particolare texture materica dall'effetto inconfondibilmente unico e raffinato.

The innovative METAL lacquered finish gives these flat doors a unmistakable surface texture with a unique, refined effect.



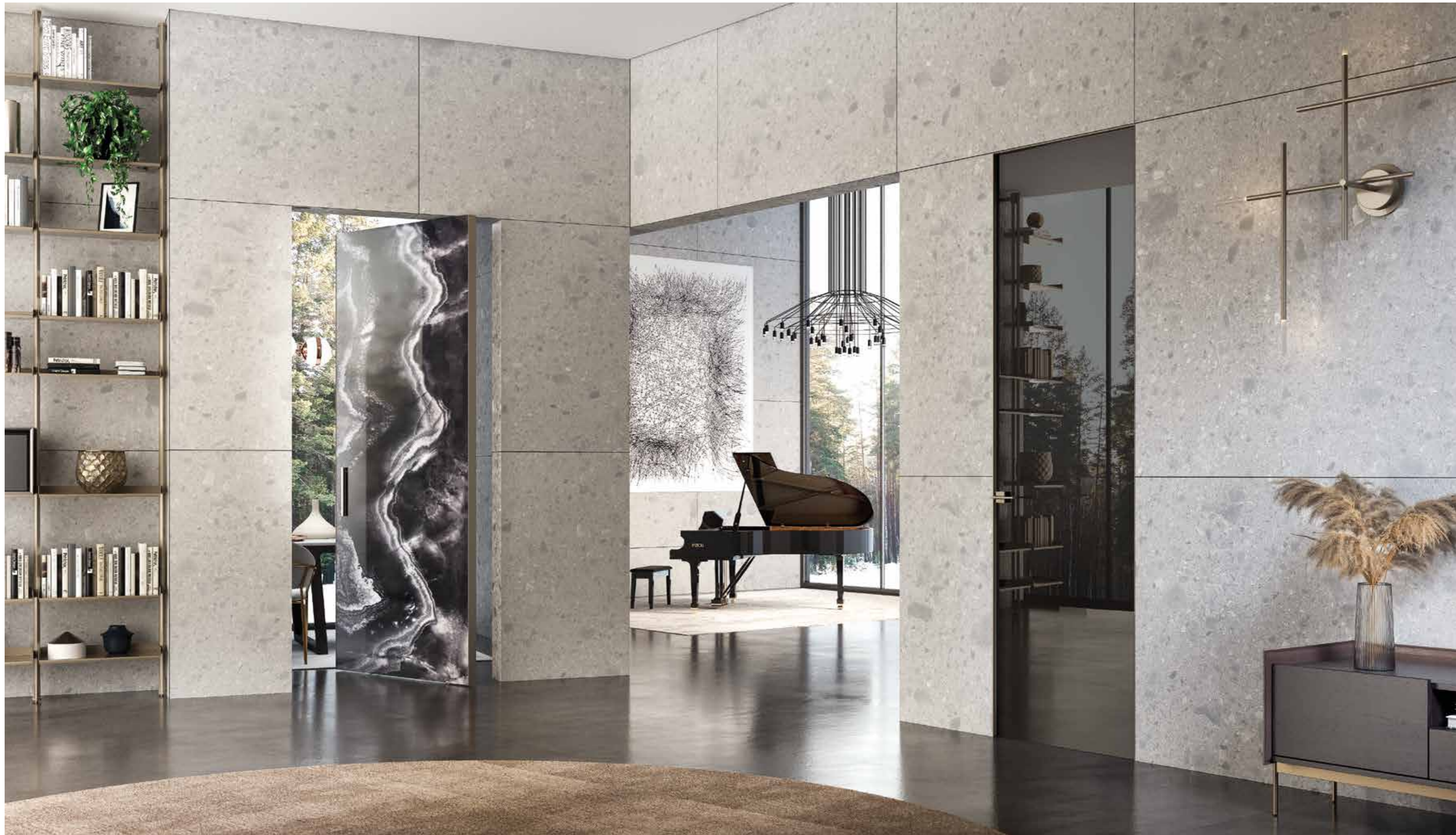





Venature spazzolate e verniciate
con cura per esaltare al massimo
ogni dettaglio della pregiata essenza.

Carefully brushed and varnished veins to exalt
every detail of the prestigious veneer.







NATNUT DOUBLE FILA,
TIPA30

CREDITS WOWDOM

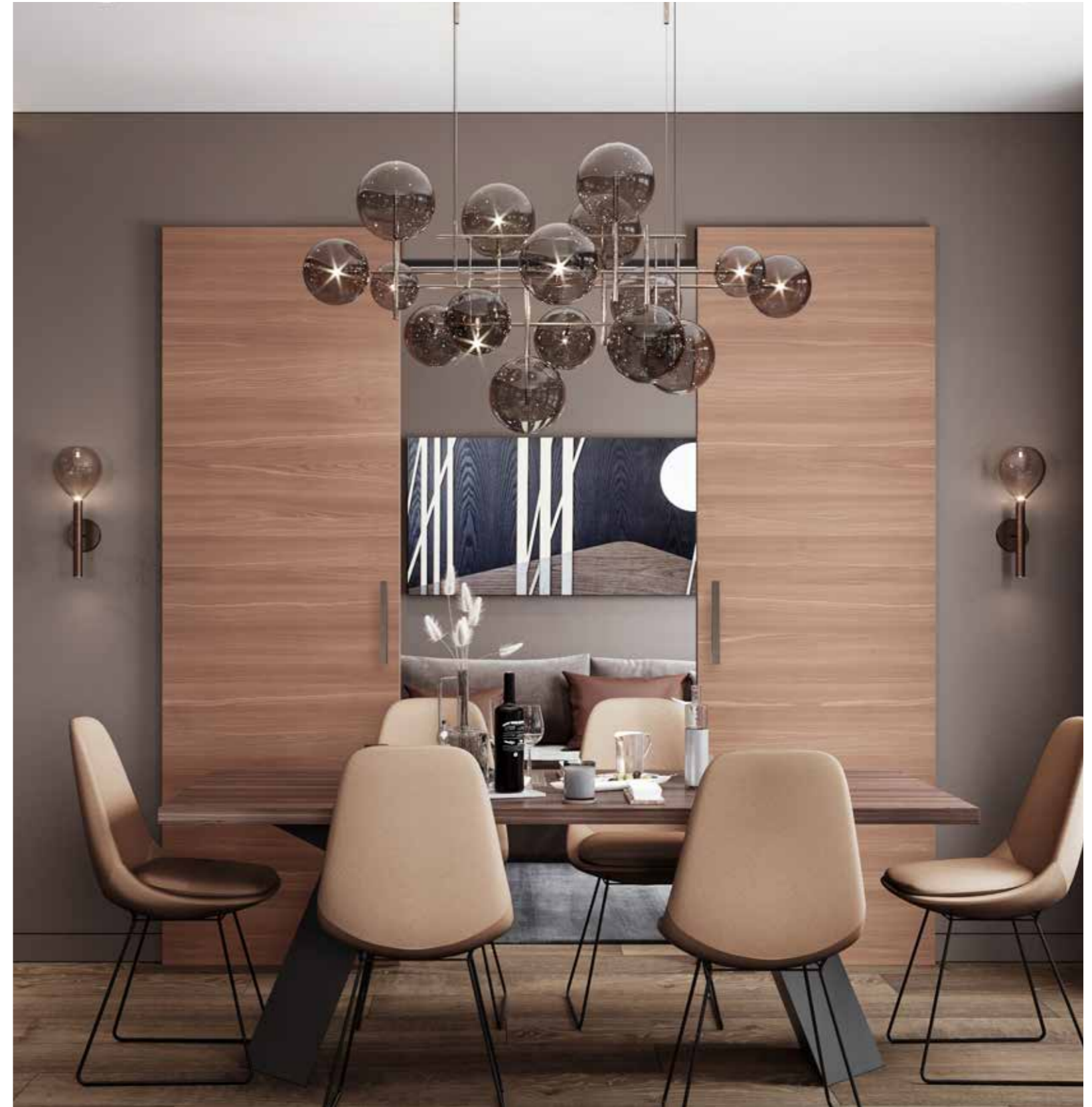

Un'elegante soluzione di scorrevole a parete – FILA, per creare una connessione tra gli ambienti dining e living. Suggestiscono un'alternativa alla composizione dello schema distributivo, unendo e dividendo gli spazi con grande effetto scenico.

This is an elegant solution with barn doors – FILA, to create a connection between the dining and living rooms. It suggests an alternative to distributing the furnishings while joining and dividing spaces with a strikingly scenic effect.



Per chiudere grandi aperture aggiungendo un tocco di stile. Barausse propone una combinazione di ante a bilico di grandi dimensioni consente di ottenere aperture modulari e un forte impatto estetico.

Closing wide openings with a touch of style is easy. Barausse suggests using a combination of large pivoting doors to create modular openings with strong aesthetic impact.



Secret You

YOU rappresenta la soluzione per realizzare porte capaci di accogliere decorazioni o rilievi customizzabili. Abbiamo elevato la percezione di un oggetto funzionale che nasconde e svela simultaneamente, e il cui criterio progettuale si ispira al principio dell'organicità.



YOU is the right solution to make large doors that can hold decorations or customizable relief patterns. We have raised the perception of a functional object that hides and reveals simultaneously, and the design criteria was inspired by the principle of cohesiveness.





Porta a bilico rivestita in marmo Margraf
Pivot door decorated with Margraf marble

La porta filomuro SECRET YOU è la soluzione invisibile per eccellenza. Si integra completamente con le pareti circostanti per mimetizzare il passaggio.

The SECRET YOU flush door is the invisible solution "par excellence". It integrates completely with the surrounding walls to conceal the passage.

La porte ras du mur SECRET YOU est la solution invisible par excellence. Elle s'intègre complètement avec les murs pour camoufler le passage.

La puerta a ras con la pared SECRET YOU es la solución invisible por excelencia. Se integra completamente con las paredes circunstantes para camuflar el pasaje.

Дверь заподлицо SECRET YOU - это невидимое решение по преимуществу. Они плотно прилегают к окружающим стенам и растворяются в них, словно невидимые.



Moderno collection

Moderno



Superfici verniciate con cura, seguendo un attento processo di laccatura a spruzzo o a velo a seconda delle finiture, per esaltare al massimo ogni dettaglio: le porte laccate Color e Metal sono concepite per valorizzare e conferire luminosità ed eleganza agli ambienti in cui vengono inserite.

Carefully painted surfaces are obtained through a painstaking process of spraying or curtain coating lacquer, depending on the finishes, to get the most out of each detail: the Color and Metal lacquered doors were designed to add value and elegance while brightening the room where they are installed.

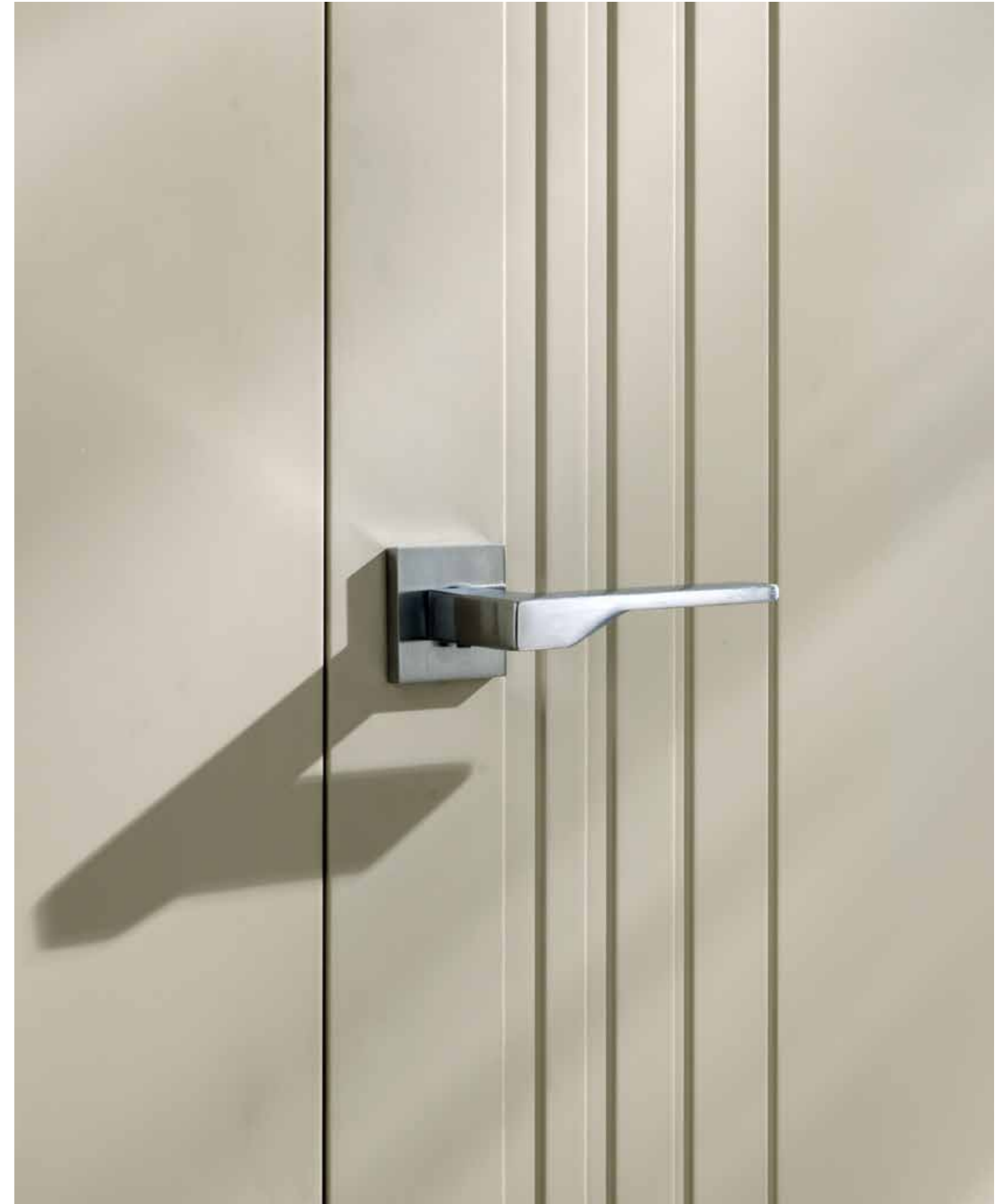





I modelli Coloniale sono caratterizzati da una raffinata pantografatura che coniuga perfettamente il gusto classico e moderno.

The Coloniale models have a refined pantographic milled pattern that perfectly combines classic and modern styles.





Il top delle cerniere invisibili registrabili su 3 assi. Le cerniere installate completamente all'interno del profilo consentono un maggiore spessore di rasatura evitando il rischio di formazione di crepe nel muro.

The best invisible hinges on the market, adjustable on 3 axes. Avoids the risk that, with time, cracks appear on the wall: the positioning of the hinges allows to have a thicker wall finishing into the wall.

ST311
moved by excellent  **SIMONSWERK**



Satin Chrome (CS)



Matt Black (NO)



Matt White (BO)

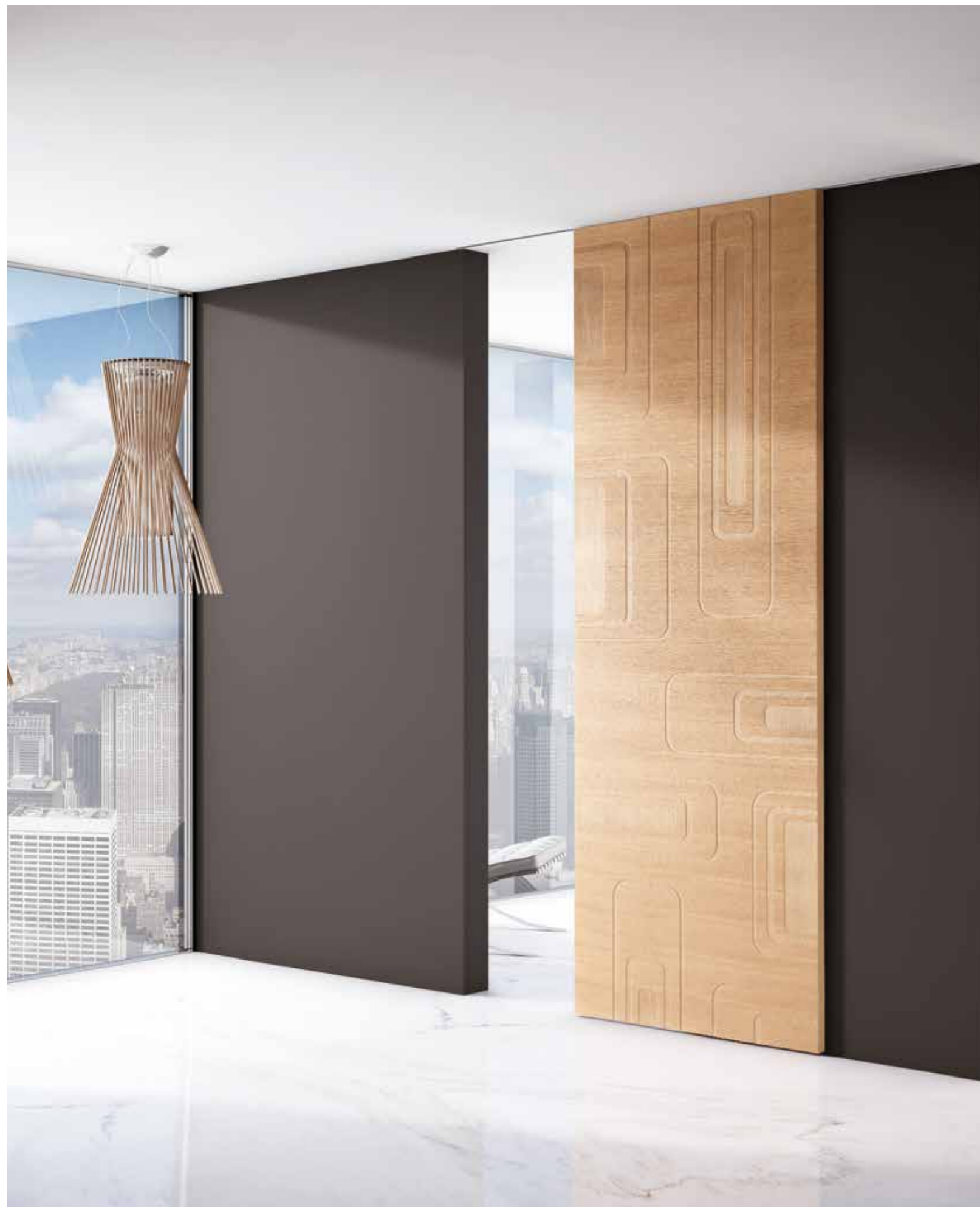

Venature spazzolate e verniciate con cura per esaltare al massimo ogni dettaglio della pregiata essenza: le porte in legno della collezione Nature Barausse sono concepite per arredare e dividere gli spazi con il pregio del legno e il fascino delle sue irregolarità, in equilibrio tra classico e contemporaneo.

Carefully brushed and varnished veins to highlight every detail of the prestigious veneer: the wood doors of Nature Barausse collection are conceived to furnish and divide spaces with quality wood and the charm of its irregularities, in balance between classic and contemporary.

Des veines brossées et soigneusement vernies pour maximiser chaque détail de l'essence précieuse: les portes en bois de la collection Barausse Nature sont conçues pour meubler et diviser les espaces avec la valeur du bois et le charme de ses irrégularités, dans un équilibre entre classique et contemporain.

Grano de madera cepillado y acabado con barniz especial para exaltar al máximo cada detalle de la chapa preciosa: las puertas de madera de la colección Nature Barausse son concebidas para decorar y dividir los espacios con el calor de madera y el encanto de sus irregularidades, en equilibrio entre el estilo clásico y el estilo contemporáneo.

Обработанные щеткой и тщательно покрытые лаком прожилки, чтобы максимально подчеркнуть каждую деталь драгоценной сущности: деревянные двери коллекции Barausse Nature созданы, чтобы отделить и разделить пространство ценностью дерева и очарованием его неровностей в балансе между классикой и современностью.





Venature marcate, accentuate nella matericità dall'innovativa laccatura Eco Nature per un effetto naturale. Ad impreziosire l'anta i profili geometrici degli inserti che conferiscono grande pregio.

The innovative Nature Eco lacquered finish highlights the marked wood grain, accentuated to obtain a natural look. To embellish the door, the geometric profiles of the inserts convey a sense of prestige.

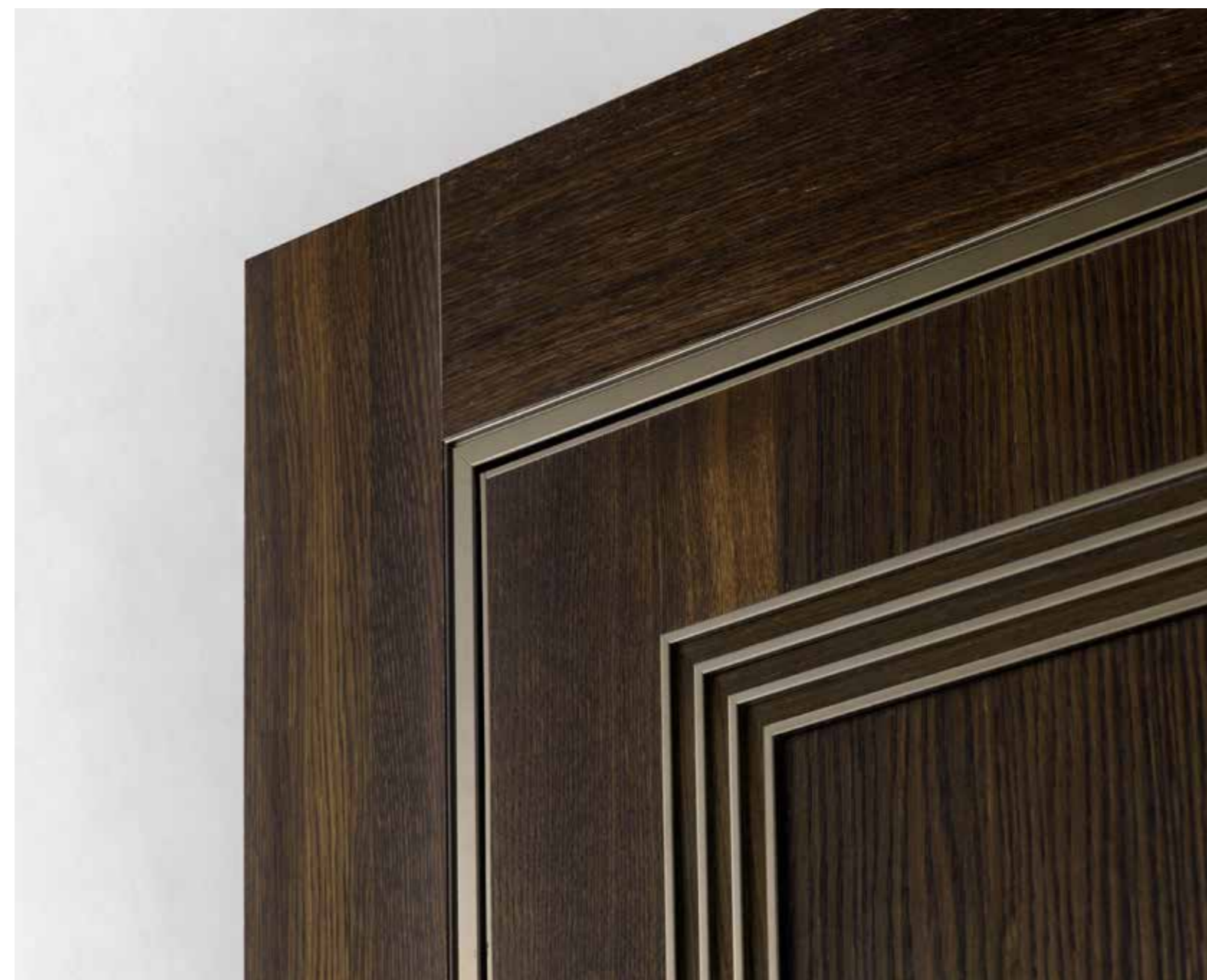
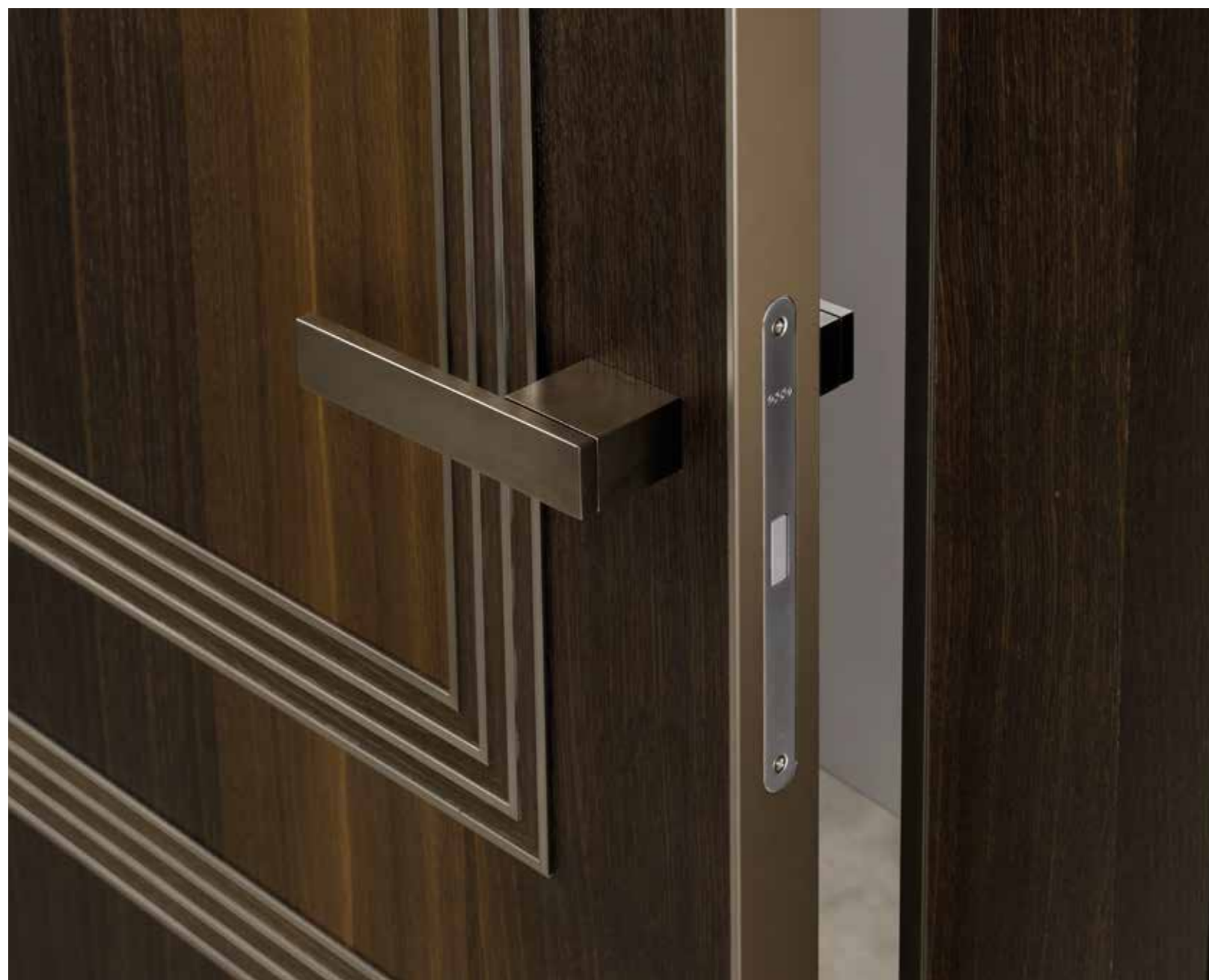





Classico collection

Classico



L'interpretazione del gusto classico in chiave moderna; influenzato da forme morbide e particolarmente articolate, mantengono un fil rouge con tutte le altre linee Barausse: decise e raffinate per elevare gli ambienti in cui vengono inserite. Novità per questa collezione, è l'introduzione delle finiture METAL per uno stile ricercato che fa tendenza.

This is a modern interpretation of classic taste. Influenced by soft, particularly complex shapes, these doors have a clear connection to the other Barausse lines: a decisive, refined look that never fails to enhance the rooms where they are installed. A new aspect of this collection is the introduction of METAL finishes for a sophisticated trend-setting style.

L'interprétation du style classique dans une optique moderne ; influencé par des formes douces et parfaitement agencées, elles conservent un lien avec toutes les autres lignes Barausse: caractère et raffinement pour exalter les environnements auxquels elles sont intégrées. Une nouveauté pour cette collection, l'introduction des finitions METAL pour un style raffiné et trendy.

La interpretación del gusto clásico en clave moderna; influencias de formas suaves y particularmente articuladas, mantienen un hilo conductor con todas las demás líneas Barausse: firmes y refinadas para elevar los ambientes en los que se colocan. La novedad de esta colección es la introducción de acabados METAL para conseguir un estilo refinado que marca tendencia.

Представление классики в современном ключе: обретя мягкие и очень сложные формы, они сохранили приверженность концепции, объединяющей все остальные линейки Barausse: решительность и изысканность для повышения класса помещений, в которые они будут устанавливаться. Новинка этой коллекции - отделка из METAL в утонченном модном стиле.

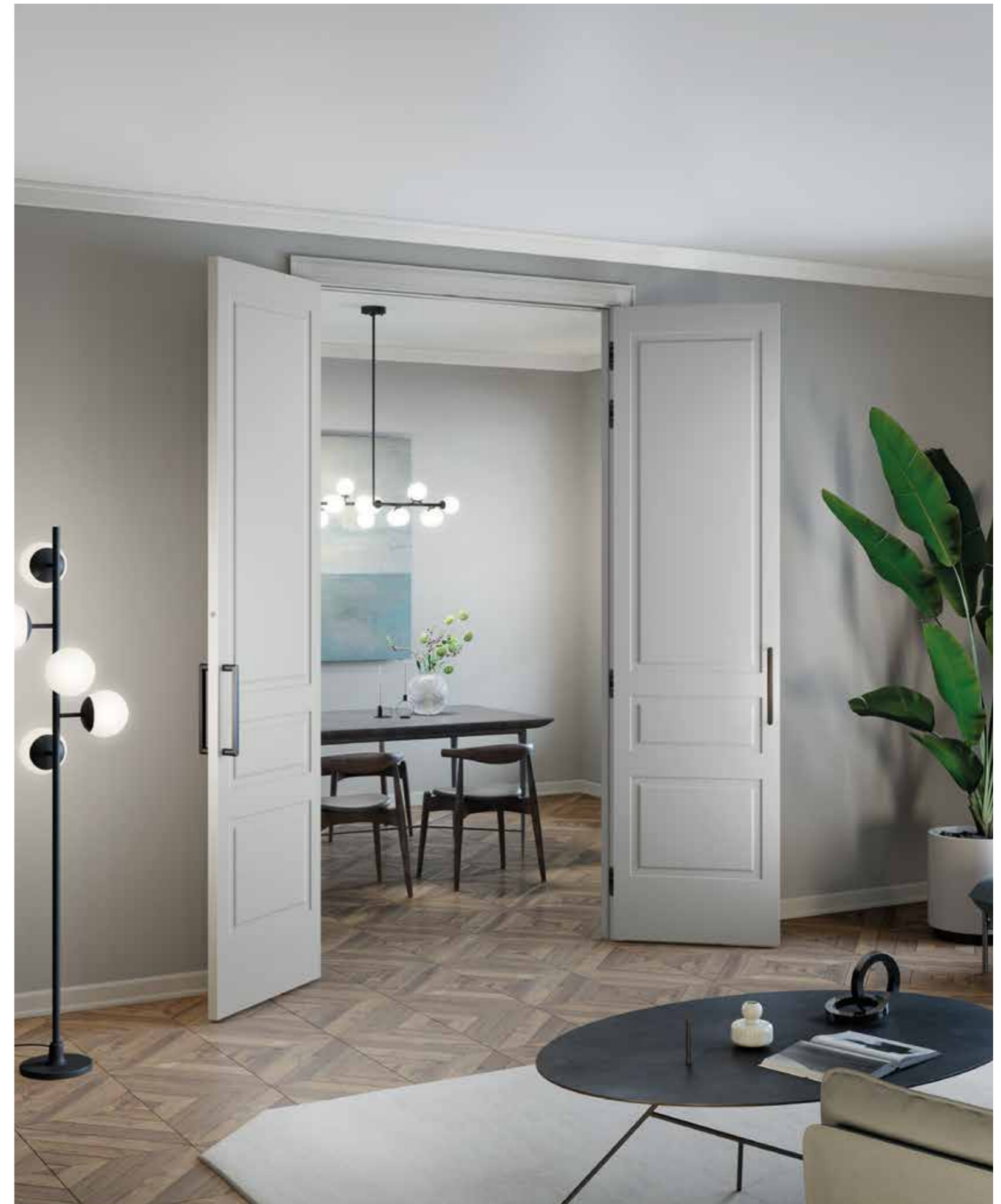





GIOTTO 02



GIOTTO G

La collezione Giotto, si rinnova con l'entrata della linea pantografata. Questa collezione dalle linee graziose suggerisce nuovi scenari di utilizzo, un perfetto equilibrio tra classico e moderno.

The Giotto collection is renewed with the addition of a milled line. The graceful lines of this collection suggest new scenarios and a perfect balance between classic and modern style.









OPEN 01PP



OPEN 08PP



OPEN 08PU - TN



OPEN 08PU - ERA STILE

OPEN nasce dall'evoluzione della tradizionale porta pannellata. Il risultato è una linea versatile, elegante e discreta in grado di interpretare gli spazi in chiave moderna o classica in base alle necessità del progetto, grazie all'ampio ventaglio di finiture e all'abbinamento con cornici semplici o sagomate.

OPEN has evolved from the traditional panel door. Its versatile, distinct line can elegantly interpret spaces with a hint of modern or classic style depending on the project requirements, thanks to a wide range of finishes and combinations with simple or moulded frames.







Door and wall panelling system

Sistema porte & boiserie









La proposta Barausse di Boiserie e Lambris mira ad arredare in maniera sartoriale, e in continuità con la finitura delle porte, anche le pareti perimetrali della stanza. Essenze legno, finiture laccate personalizzate, dettagli lineari o raffinate modanature sono le protagoniste ideali per conferire all'ambiente uno stile inconfondibile nella sua accezione classica o moderna.

The Barausse solutions for Boiserie and Lambris offers a tailor-made option to decorate the walls of the entire room in continuity with the finish of the doors. Wood essences, customized lacquered finishes, linear details or refined mouldings are the ideal features to give the environment a unique style in a classic or modern way.

La ligne Barausse Boiserie et Lambris vise à ammobler d'une façon sur mesure et en continuité avec la porte, y compris les murs de perimetre de la chambre. Essences en bois, finitions laquées personnalisées, les détails linéaires ou moulures raffinées sont les protagonistes idéaux pour donner à l'ambiance un style distinctif dans son sens classique ou moderne.

La línea Barausse de Boiserie y Lambris pretende amueblar de forma sartorial, y en continuidad con el acabado de las puertas, incluso los muros perimetrales de toda la habitación. Esencias de madera, lacados personalizados, detalles lineales o molduras refinadas son los protagonistas ideales para dotar al ambiente de un estilo inconfundible en su sentido clásico o moderno

Линия Barausse Boiserie и Lambris направлена на то, чтобы обустроить периметр стен всей комнаты в соответствии с индивидуальной отделкой дверей. Решения из дерева и натурального шпона, лакированная отделка по индивидуальному заказу, линейные детали или изысканные лепные украшения, – идеальные герои, чтобы придать окружающей среде безошибочный стиль в его классическом или современном смысле.



Models

Modelli



Laccato / Lacquered

Modelli lisci e pantografati / Plain and milled models

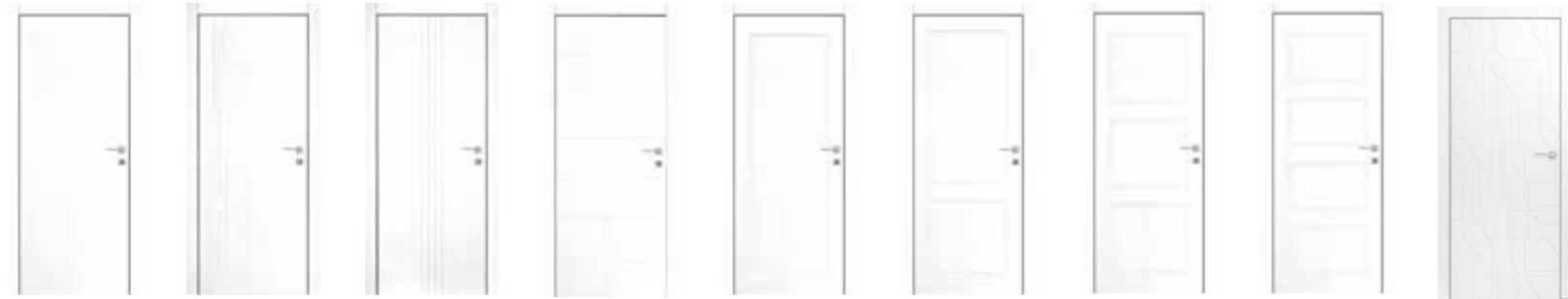

ON TRATTO 2 TRATTO 4 TRATTO 10 QUADRO 1 QUADRO 2 QUADRO 3 QUADRO 4 OTTAGONO



VALZER BIT EAN GEOMETRIA P DUNE LUCIO 10 LUCIO 20 LUCIO 30 GRAFFIATA



FEBE 10 FEBE 20 AURA PURA COLONIALE 21G COLONIALE 22G

Modelli vetrati / Glass models



ONGA RVU RVUG4 RVUG5

Open



01PU 01PP 08PU 08PP 01VU 01VP 08VP 15PU 15PP

Giotto



GIOTTO 02PU GIOTTO 02PP GIOTTO 02VU GIOTTO 02VP 11G 12G 13G

Palladio



PALLADIO PP PALLADIO VP PALLADIO VU PALLADIO 121PU PALLADIO 122PP PALLADIO 124PP PALLADIO 126PP PALLADIO 122VP PALLADIO 121VU

Doge



DOGE PU DOGE PP DOGE PPP DOGE SP DOGE VU DOGE VP DOGE VPP

Laccato / Lacquered

Antica Venezia



0G 2G 3G 4G 5G 6G 7G 8G 2GV



5GV 6GV 7GV 8GV

Burano



PU PP PPP VU VP VPP

Tiepolo



1BB 1BV 1VU 2BB 2VB

Materia

Vetri / Glass



TR MARMO VSL SSP VANITÀ SSP FUMÉ SSP BRONZO

Effetto pietra / Stone effect



ROCK TRAVERTINO

Baklite / Concrete effect



ARDESIA CEMENTO CORDA PIETRA

Pelle / Leather



B N

Shiny



BIANCO LATTE CREMA TORTORA GRIGIO NERO

Effetto legno / Wood effect



QUERCIA MOKA WALNUT PERLA OTTER BRINA GHIACCIO

Legno / Wood

Naturoc



ON IN DECO 1 DECO 1L DECO 1Q DECO 2Q DECO 2L BIT EAN

Tabacco



IN KIN DECO 1 DECO 1L DECO 1Q DECO 2Q DECO2L INGA RVU



GRAFFIATA ONGA INGA RVU RVUG4 RVUG5

Masai



ON ONGA RVU RVUG4 RVUG5

Ice



ON ONGA RVU

Nodato



ON IN ONGA INGA ON IN ONGA INGA RVU

Sigaro

Natnut



ON ONGA RVU

Olmo



ON IN

Gralley

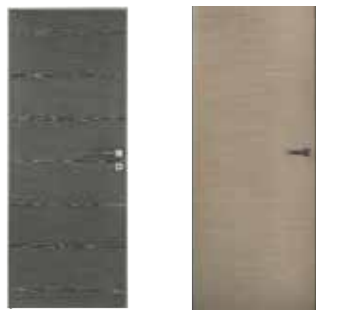

ON ON

Sesamo

Cenere



ON IN ONGA INGA RVU RVUG4 RVUG5

Finiture



Legno

Lo stile che deriva dall'uso di un materiale naturale quanto più unico come il legno, rendono il prodotto incomparabile e duraturo nel tempo.

Wood

The kind of style which derives from use of a natural, unique material as wood is, makes any product incomparable and evergreen.

Bois

Le style résultant de l'utilisation d'un matériel naturel et unique comme le bois rend chaque produit incomparable et durable.

Madera

El estilo de un material natural tan único como la madera hace que el producto sea incomparable y sin tiempo.

Дерево

Стиль, который исходит от использования натурального материала, такого же уникального, как дерево, делает продукт несравненным и долговечным.



Laccato

Per uno stile vivace e luminoso, le porte laccate sono disponibili in un infinito ventaglio di colori. La finitura avviene con vernici all'acqua, nel pieno rispetto dell'ambiente e della salute.

Lacquered

For a lively and bright style, the lacquered doors are available in an extensive colour range. The finish is achieved with water-based paints, fully respecting both the environment and health.

Laqué

Pour un style vivant et lumineux, les portes laquées sont disponibles dans une infinité de couleurs. La finition est réalisée avec des peintures à l'eau, dans le plus strict respect de l'environnement et de la santé.

Lacado

Para un estilo vivo y luminoso, las puertas lacadas están disponibles en una gama infinita de colores. El acabado se realiza con pinturas al agua, respetando plenamente el medio ambiente y la salud.

крашенная

Для создания яркого живого стиля лакированные двери доступны в бесконечной цветовой гамме. Отделка выполнена красками на водной основе с полным вниманием окружающей среде и здоровью.

Vetro

Personalizzata da colori o effetti ottici o impreziosita da retine e tessuti, l'anta in vetro rende l'ambiente luminoso e spazioso. Barausse utilizza solamente vetri di sicurezza conformi alle norme UNI EN 12600.

Glass

Customized by colors, optical effects or embellished with internal mesh and fabrics, glass door can make the space brighter and more spacious. Barausse uses only compliant safety glass UNI EN 12600.

Verre

Personnalisé par des couleurs, des effets optiques ou agrémenté des filets et des tissus, la porte en verre peut rendre l'espace plus lumineux et plus spacieux. Tous les vitrages sont conformes aux normes de sécurité UNI EN 12600.

Cristal

Personalizado con colores, efectos ópticos o adornado con redes y telas, la puerta de cristal crea ambientes luminosos y espaciosos. Todos los vidrios responden a la normativa de seguridad UNI EN 12600.

стекла

Стеклопанель, выполненная в цветовой гамме, с помощью оптических эффектов или украшенная сетками и тканями, делает пространство светлым и просторным. Barausse использует только защитные стекла, соответствующие стандартам UNI EN 12600.

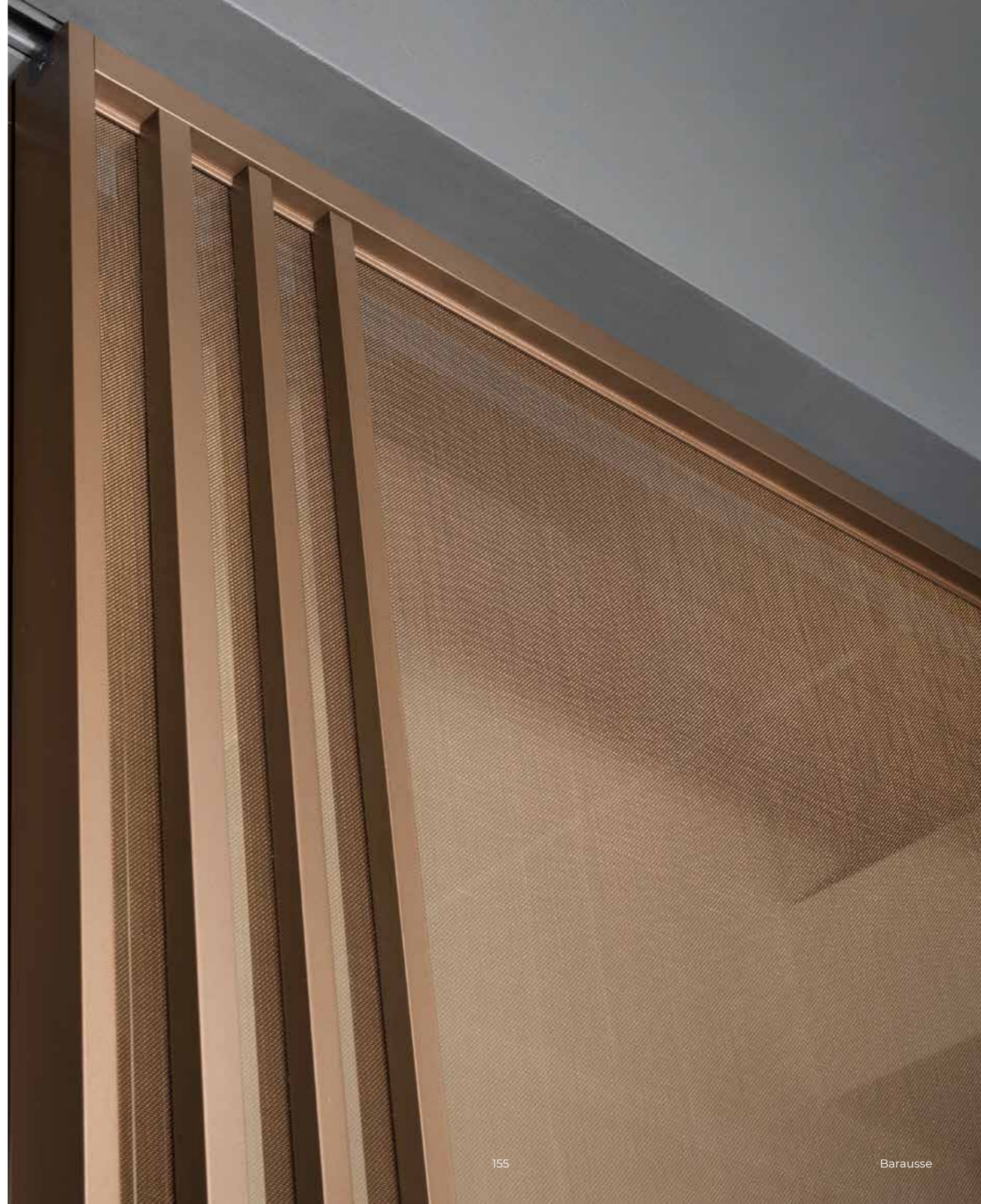



You

La soluzione verniciabile rappresenta la base per la massima personalizzazione dell'ambiente agevolando l'applicazione di carte da parati e finiture murali.

YOU paintable

This paintable solution represents the perfect support for the highest customization of the space by facilitating the application of wallpapers and wall finishes.

YOU à peindre

Cette solution à peindre représente le support idéal pour une utilisation optimale de l'espace en facilitant l'application de papiers peints et de revêtements de murs.

YOU pintable

La solución pintable permite la máxima personalización del entorno facilitando la aplicación de papeles pintados y acabados de paredes.

YOU под покраску

Раскрашиваемое решение представляет собой основу для максимальной индивидуализации окружающей среды за счет облегчения нанесения.

Materia

Pelle, cemento, alluminio, solo alcuni dei materiali selezionati per rendere unico il contesto in cui è inserito.

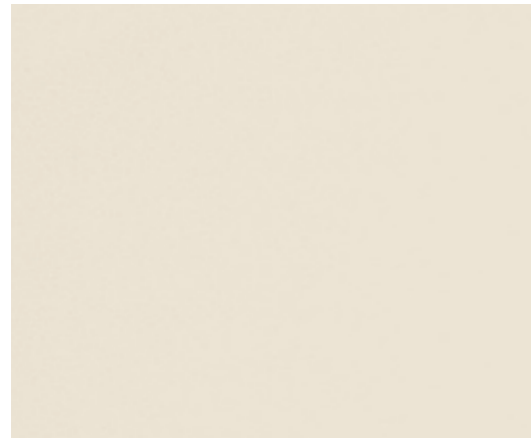

Shiny

La superficie lucida capace di riflettere gli oggetti al quasi come uno specchio conferisce brillantezza ed eleganza agli ambienti.



Effetto Alluminio

L'innovativa laccatura consente di ricreare la brillantezza e raffinatezza dell'alluminio ampliando la gamma di soluzioni.

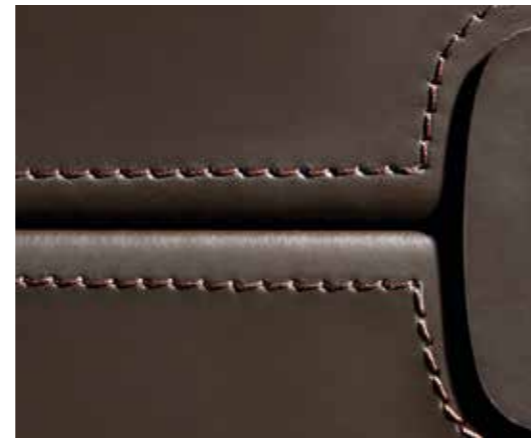

Pelle

La percezione di questo materiale naturale e prezioso trasmette al contempo resistenza ed esclusività.

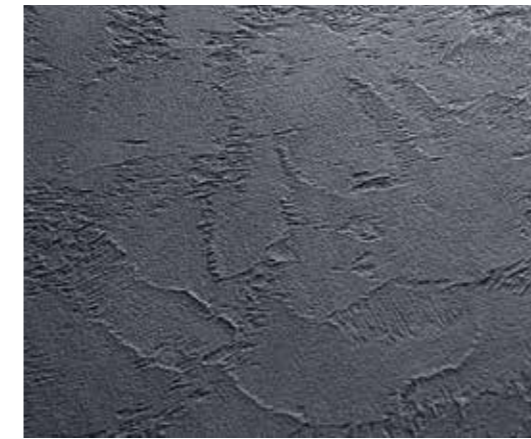

Effetto Cemento

L'aspetto materico e la disomogeneità tipica della lavorazione artigianale conferiscono stile contemporaneo e unicità agli ambienti.



Effetto Pietra

Uno speciale materiale dal marcato effetto materico garantisce l'applicazione a tutte le soluzioni funzionali.

Shiny

The gloss finishing surface which reflects images almost like a mirror, is able to give brilliance and elegance to any room.

Shiny

La surface brillante, qui reflète les images presque comme un miroir, est capable de donner de la brillance et de l'élégance à tous les ambiances.

Brillante

La surface brillante, qui reflète les images presque comme un miroir, est capable de donner de la brillance et de l'élégance à tous les ambiances.

Глянec

Глянцевая поверхность, способная отражать предметы почти как зеркало, придает среде блеск и элегантность.

Aluminum Effect

The kind of style which derives from use of a natural, unique material as wood is, makes any product incomparable and evergreen.

Effet Aluminium

Le style résultant de l'utilisation d'un matériel naturel et unique comme le bois rend chaque produit incomparable et durable.

Efecto Aluminio

El estilo de un material natural tan único como la madera hace que el producto sea incomparable y sin tiempo.

Эффект Алюминий

Стиль, который исходит от использования натурального материала, такого же уникального, как дерево, делает продукт несравненным и долговечным.

Leather

The feeling of this natural and precious material confers resistance and exclusivity sensations.

Cuir

La sensation de ce matériel naturel et précieux confère des sensations de résistance et d'exclusivité.

Cuero

La percepción de este material natural y precioso transmite al mismo tiempo resistencia y exclusividad.

Кожа

Восприятие этого природного и драгоценного материала передает одновременно прочность и эксклюзивность.

Concrete Effect

The material appearance and typical irregularity of surface, which strongly reminds to craftsmanship contributes to create a contemporary and unique style in the setting.

Effet Béton

L'apparence matérielle et l'irrégularité typique de la surface, qui rappellent fortement l'artisanat créent un style contemporain et unique dans les ambiances.

Efecto Hormigón

El aspecto material y la falta de homogeneidad típica de la artesanía le dan un estilo contemporáneo y unicidad a los ambientes.

Эффект Цемента

Материальный аспект и неоднородность, характерные для ремесленного мастерства, придают среде современный стиль и уникальность.

Stone Effect

A special material with a marked "material" effect which is granted to be applied to any functional solution.

Effet Pierre

Matériel spécial à effet matériel, marqué, il garantit de pouvoir être appliqué à toutes solutions fonctionnelle.

Efecto Piedra

Un acabado especial con un marcado efecto de material garantiza la aplicación a todas las soluciones funcionales.

Эффект Камня

Специальный материал с выраженным материальным эффектом гарантирует применение при всех функциональных решениях.

Colore

color

LACCATO

lacquered - laqué - lacado
крашенная



BLANC

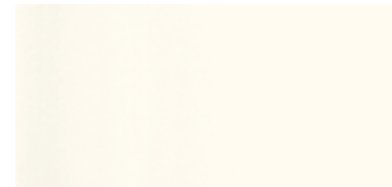

MAGNOLIA

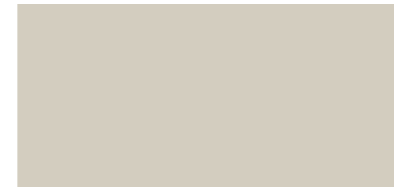

TORTORA



NUVOLA

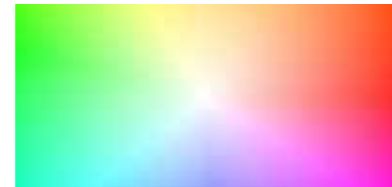

COLOR

LACCATO SOFT

soft lacquered - laqué soft - lacado
soft - soft крашенная

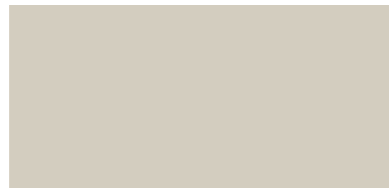

TORTORA SOFT



NUVOLA SOFT



GRIGIO SOFT



TALPA SOFT



COLOR SOFT

LACCATO RIFINITO A MANO

lacquered and finished by hand
laqué fini à la main - lacado
acabado a mano - крашенный
расписанный вручную



1610



1620



1630

LUCIDO

shiny - brillant - brillante
гляцевый

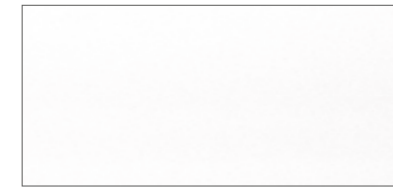

BIANCO

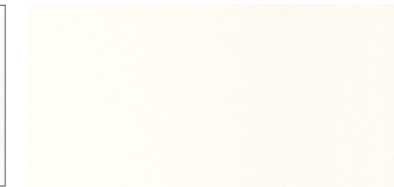

LATTE

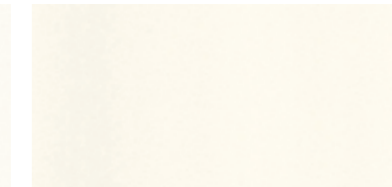

CREMA

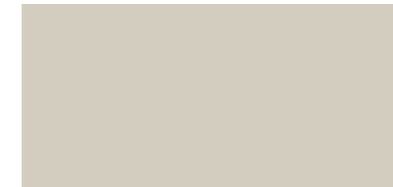

TORTORA SHINY



GRIGIO SHINY

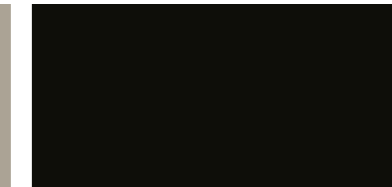

NERO SHINY

LACCATO METAL

METAL lacquered - laqué METAL
lacado METAL - METAL крашенная



ALUM



TITANIO



CHAMPAGNE



ORO



BRONZE



BRONZO ANTICO



RAME



CARBON

Legno

wood

NATURE ECO

tranciato di legno - pure wood veneer
placage de bois - chapa de maderá -
древесный шпон



NATUROC

rovere naturale spazzolato - natural
brushed oak - chêne brossé naturel
roble natural cepillado - дуб
натуральный брашированный



NODATO

rovere naturale nodato spazzolato
natural brushed oak with knots -
chêne brossé naturel, noeuds en vue
roble natural cepillado con nudos -
натуральный брашированный дуб
с узловатостями



NATNUT

noce americano - american walnut
noyer américain - nogal americano
орех американский



SIGARO

rovere naturale spazzolato - natural
brushed oak - chêne brossé naturel
roble natural cepillado - дуб
натуральный брашированный



CENERE

rovere grigio nodato spazzolato -
grey brushed oak with knots - chêne
brossé cendre, noeuds en vue - roble
gris cepillado con nudos - серый дуб
узловатый брашированный



TABACCO

rovere spessart termotrattato
spazzolato - spessart heat treated and
brushed oak - chêne spessart thermo
traité et brossé - roble termotrattado
cepillado - термообработанный
брашированный дуб

NATURE

tranciato di legno verniciato a poro
aperto - pure wood veneer
with open pores - placage de bois
verni à pores ouverts - chapa de
maderá barnizada de poro abierto -
древесный шпон лакированный
с открытыми порами



COLOROC

rovere laccato - lacquered oak -
chêne laqué - roble lacado - дуб
лакированный



ICE

frassino laccato blanc spazzolato -
blanc lacquered brushed ash -
frêne laqué blanc brossé - fresno
lacado blanc cepillado - ясень
брашированный blanc крашенная



MASAI

rovere nero spazzolato - black brushed
oak - chêne noir brossé - roble negro
cepillado - дуб брашированный
черный

ESSENZE

piallaccio di legno precomposto -
reconstructed wood veneer - placage
de bois reconstitué - chapa de
maderá precompuesta -
многослойный шпон

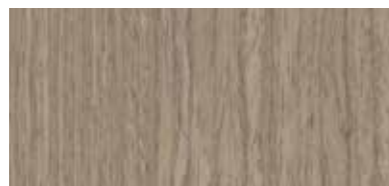

SESAMO

tranciato precomposto -
reconstructed wood veneer - placage
de bois reconstitué - chapa de
maderá precompuesta -
композиционный деревянный шпон



OLMO

olmo - elm - orme - olmo - вяз



GRALLEY

rovere grigio - grey oak - chêne gris
roble gris - дуб серый

Materico

materico

BAKLITE EFFETTO CEMENTO

concrete effect - effet béton -
Эффект цемента - efekt cementu
efecto del hormigón



CEMENTO



CORDA



PIETRA

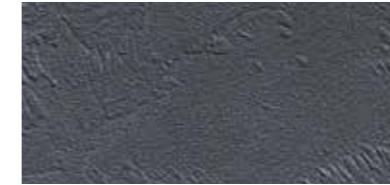

ARDESIA

EFFETTO PIETRA

stone effect - effet pierre - efecto
piedra - под камень



TRAVERTINO



ROCK

PELLE

leather - cuir - piel - кожа



B



N

EFFETTO LEGNO

wood effect - effet bois - efecto
maderá - эффект дерева



GHIACCIO



BRINA



OTTER



QUERCIA



PERLA



WALNUT



MOKA

Vetro

glass

TRASPARENTE

transparent - transparent -
transparente - прозрачное

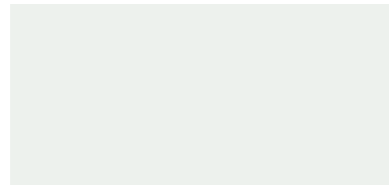

VT TR EXTRA

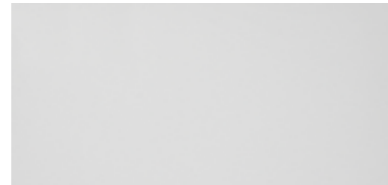

VST TR



VT TR FUMÉ



VT TR BRONZO



SS FUMÉ



SS BRONZO

SATINATO

frosted - satiné - satinado - матовое

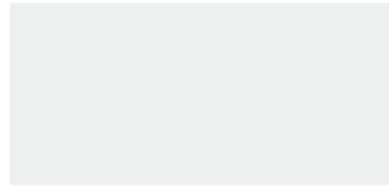

VSS SB EXTRA



VSS SB



VTS FUMÉ

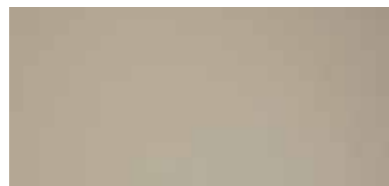

VTS BRONZO

SPECCHIO

mirror - miroir - espejo - зеркало



SSP VANITÀ



SSP FUMÉ



SSP BRONZO



SSP ANTICA VANITÀ

DECORATO

decorative glass - vitrage décoré
vidrio decorado - стекла
прозрачные с декором

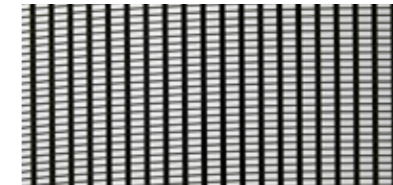

TR FUMÉ M1

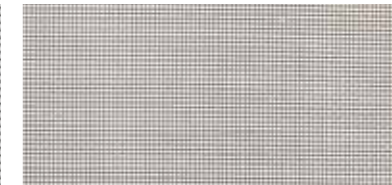

TR M2

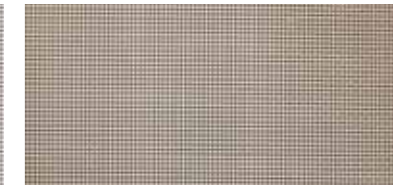

TR BRONZO M2



TR EXTRA L1



VSD LINEN



VSD LINEA



TR EXTRA PRINT



TR FUMÉ PRINT



TR BRONZO PRINT



TR EXTRA P1



TR PRINT MARMO

LACCATO COLORE LUCIDO

back lacquered - vitrage laqué -
vidrio lacado - лакированное
блестящее



VSL

Telai alluminio

aluminum frames

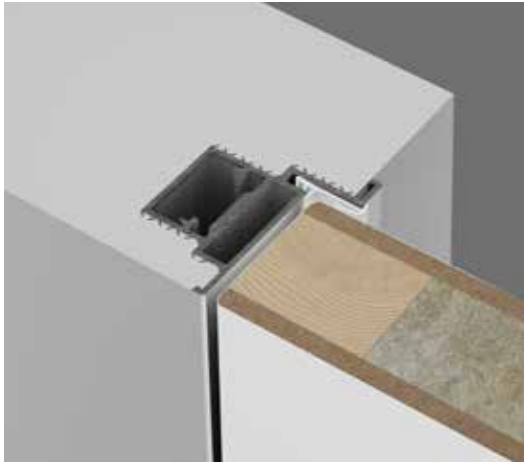

SECRET / flush on the pull side

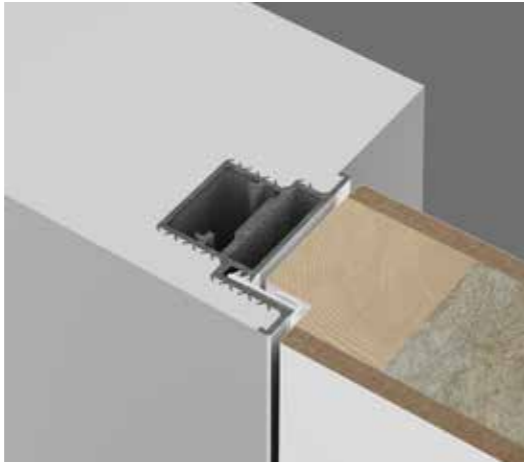

SECRET / flush on the push side

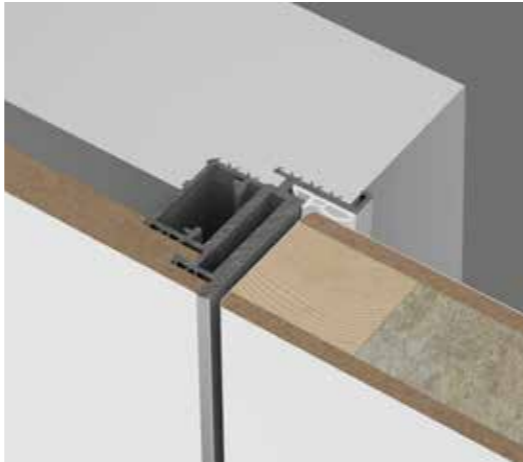

TECNOSECRET / flush on the pull side



INNER X1 / flush on the pull side

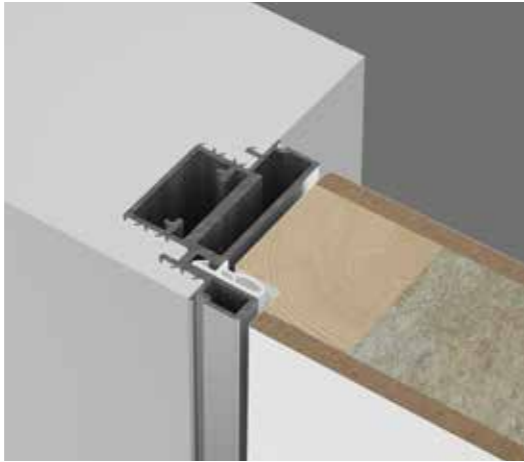

INNER X1 / flush on the push side



INNER2 / flush on the pull side

Telai legno

wooden frames



ERA STILE / push side



ERA GIOTTO / push side



ERA PALLADIO / push side

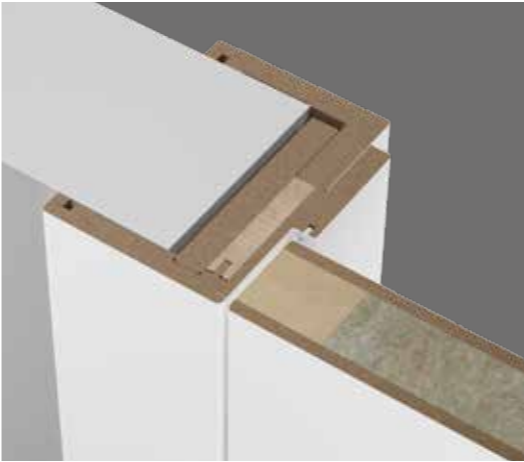

TN / flush on the pull side

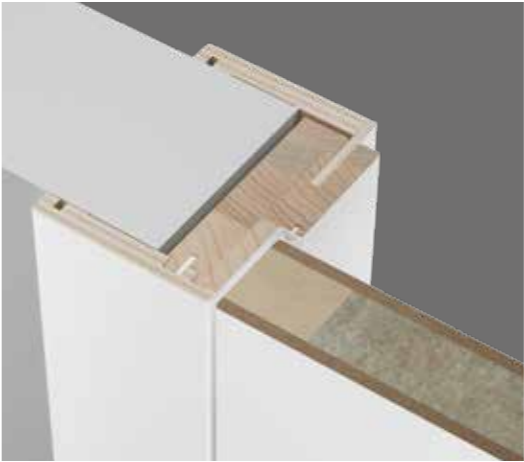

TN PLUS / flush on the pull side

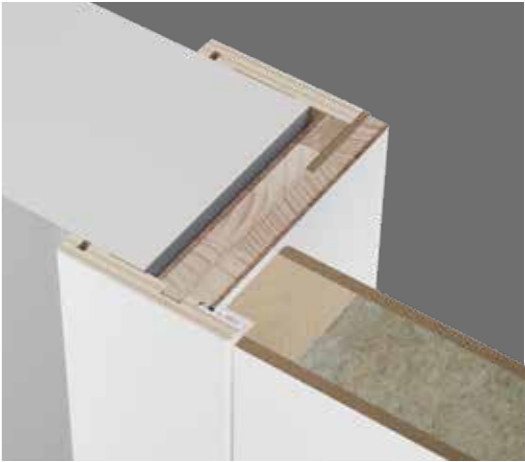

TN PLUS INVERSO / flush on the push side

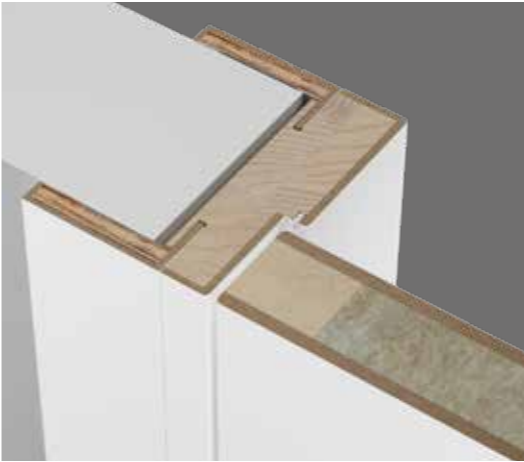

FN / pull side



Scorrevoli a soffitto

ceiling sliding door



Binario incassato

concealed rail
rail encastré
carril empotrada
рельс в потолок

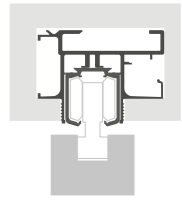

1 BINARIO
1 RAIL

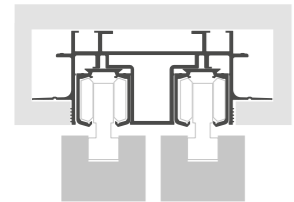

2 BINARI
2 RAILS

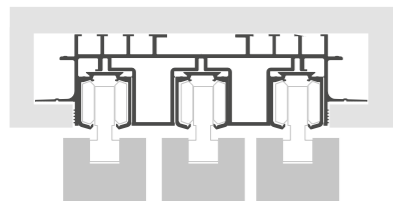

3 BINARI
3 RAILS



Binario a vista

visible pelmet
rail à vue
carril visible
внешний рельс



1 BINARIO
1 RAIL

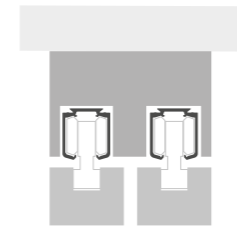

2 BINARI
2 RAILS

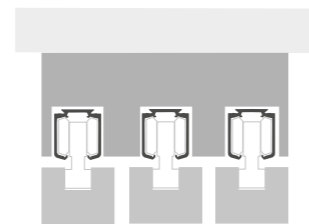

3 BINARI
3 RAILS

Scorrevoli a parete

wall mounted system

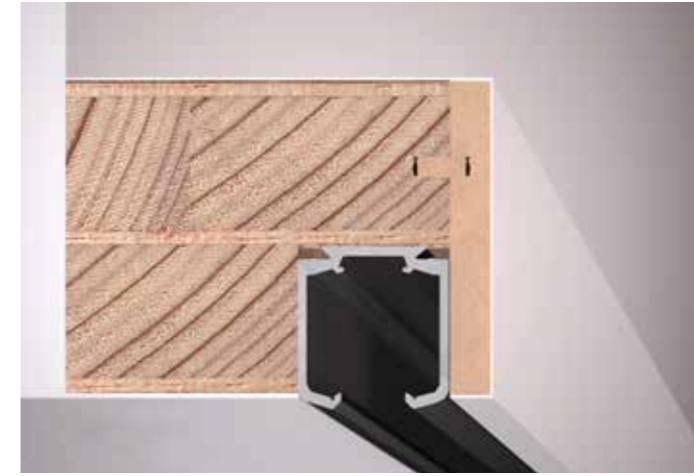

Binario a parete

wall rail
rail à mur
carril a pared
рельс вдоль стены



1 BINARIO
1 RAIL

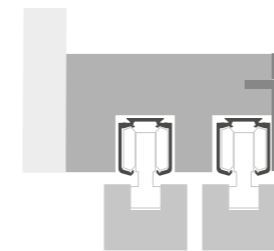

2 BINARI
2 RAILS

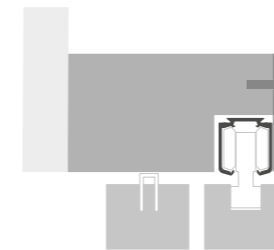

1 BINARIO, 2 VIE
1 RAIL, 2 WAYS



FILA



Maniglie
handles



Selezione Barausse



Porte tecnologiche



Porte resistenti al fuoco

Fire rated doors

						
EUROPE UNI EN 1634-1: 2014 UNI EN 1363-1: 2012 UNI EN ISO 717-1:2013 * VKF	HTB-S2 *	45 min	30 dB	----	•	----
	HTB-S3	30 min	30 / 37 dB	Sa/S200	•	----
	HTB-S7 *	30 min	41 dB	----	•	----
	HTB-S8	60 min	30 / 38 dB	Sa	•	•
RUSSIA GOST - R 53307 - 2009	FIRE RATED 30	30 min	30 / 37 / 41 dB	----	•	•
	FIRE RATED 30 WINDOW	30 min	----	----	•	•
	FIRE RATED 60	60 min	30 / 37 / 41 dB	----	•	•
	FIRE RATED 60 WINDOW	60 min	----	----	•	•
USA / CANADA UL 10C UL 1784 ASTM E84	UL 20	20 min	----	Sa	•	•
	UL 30	30 min	----	Sa	•	----

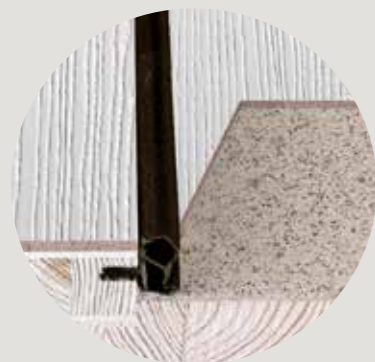

Guarnizione termoespandente VI2001A000063 Patent

Barausse ha brevettato l'applicazione di guarnizioni termoespandenti nascoste sotto l'impiallacciatura del telaio che conferiscono pulizia estetica e non richiedono manutenzione.

Barausse patented the application of intumescent strips hidden under the frame veneer, conferring an aesthetic elegance which do not require any maintenance.

Barausse a breveté l'application des joints thermodilatables installés en dessous du placage du châssis qui garantissent une propreté esthétique et ne demandent pas d'entretien.

Barausse ha patentado la aplicación de juntas termoexpansibles ocultas debajo del enchapado del marco, que no alteran la estética de la puerta y no requieren mantenimiento.

применение запатентованного терморасширяющегося уплотнителя, уложенного под шпоном короба, что дает дверям чистоту линий с эстетической точки зрения и удобно в эксплуатации.

Porte fonoisolanti

Sound proof doors

	
UNI EN ISO 717-1:2013 UNI EN ISO 140/3	30 dB
	30 / 37 dB
	41 dB
	30 / 38 dB



Soglia Mobile

È un profilo tecnico applicato nella parte inferiore dell'anta con funzioni di: isolante termico, isolante acustico, tenuta ai fumi freddi.

This is a technical profile applied to the lower part of the leaf with the following purposes: thermal insulation, acoustic insulation, cold smoke proof.

Profil technique appliqué sur la partie inférieure du vantail ayant des fonctions: isolant thermique, isolant acoustique, tenue fumées froides.

Es un perfil técnico aplicado en la parte inferior de la hoja con funciones de: aislante térmico, aislante acústico, resistencia a los humos fríos.

технический профиль, установленный в нижней торцевой части дверного полотна и служащий в качестве: термоизоляции, акустической изоляции, защиты от дыма.

21CI06
February 2022

All rights reserved. Reproduction of any part of this document and publication on the internet or any other medium is not permitted without Barausse Srl written permission. The photographic reproduction of the colours, though very similar to reality, should be considered purely indicative.

Barausse Srl reserves the right to make technical or aesthetic modifications and improvements to the products at any time without previous notice. For further information, please visit barausse.com

Barausse Srl
Via Parmesana 27
36010 Monticello Conte Otto (VI)
Vicenza – Italy

T +39 0444 900 000
info@barausse.com
barausse.com

